

Mercury Security EP1501 Intelligent Controller

PoE-enabled controller managing up to 16 input and output modules or 17 readers

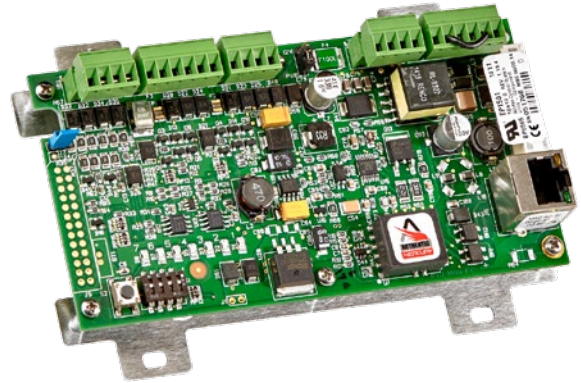

Seamlessly integrated with the Genetec Synergis IP Access Control Solution

The Synergis™ system supports Mercury Security's open field hardware enabling organizations to deploy industry-standard access control modules and protect their investments for years to come. The EP1501 is an edge-capable intelligent controller that is expandable up to 8 downstream SIO controllers and up to 16 MR51e network ready door controllers for a total of 17 readers. Supporting a range of wired and wireless reader technology, the EP1501 connects to the Synergis Cloud Link Intelligent appliance over IP. Supported RS-485 downstream panels include the Mercury Security MR52 as well as the MR51e supported over IP.

Synergis Cloud Link

Synergis Cloud Link is an intelligent and PoE-enabled gateway appliance that supports a mix of non-proprietary access control modules like the Mercury Security EP1501 Intelligent Controller. Modernize your access control environment by deploying Synergis Cloud Link over your network and establish real-time connectivity to your doors.

Overview

Connects to and reports real-time activity to the Synergis Cloud Link appliance over any IP network

Handles access control decisions and monitors activity when disconnected from the Synergis system

Supports up to 250,000 cardholders

Manages a maximum of 8 downstream MR52 devices over RS-485 and up to 16 MR51e over IP

When disconnected from Synergis, the EP1501 buffers up to 50,000 offline events and reports them once connectivity is reestablished

Additional capabilities include elevator control, hard antipassback, and offline input/output (IO) linking

UL 294 and UL 294B recognized components

OSDPv2 supported

Available Interfaces

Readers: 2 reader ports or 1 2-wire RS-485 reader port capable of supporting two readers

Inputs: 2 general purpose programmable circuit type, and dedicated tamper

Outputs: 2 relays Form C, 2A @ 30Vdc



Choose the Synergis IP access control solution to protect your people and assets with your choice of widely-deployed, non-proprietary, and secure access control hardware.

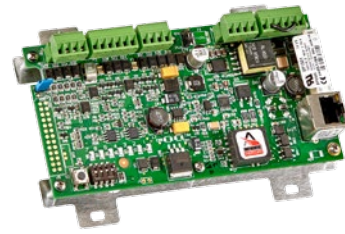

◀ Mercury Security EP1501 Intelligent Controller

Specifications Table

Dimensions	6.0 in × 8.0 in × 1.0 in (152 mm × 203 mm × 25 mm)
Operating Temperature	0-70°C operational, -55-85°C storage
Communications Ports	10/100 Ethernet

Certifications	UL 294 and UL 294B Recognized, CE Compliant, ROHS, FCC Part 15 Class A, NIST Certified Encryption, ULC-S319 (See Synergis Cloud Link Hardware Installation Guide), EN-60839-11-1
Warranty	24-month warranty. Please refer to Genetec Sales Policy for more information

Architecture ▼

Connected to the Synergis Cloud Link Appliance over IP, the Mercury EP1501 is an IP ready intelligent controller that is expandable up to 8 serial input/output devices and up to 16 MR51e network-ready door controllers. 1 reader port can be used for an additional 2 readers (1 access point) representing access control for up to 17 access points.

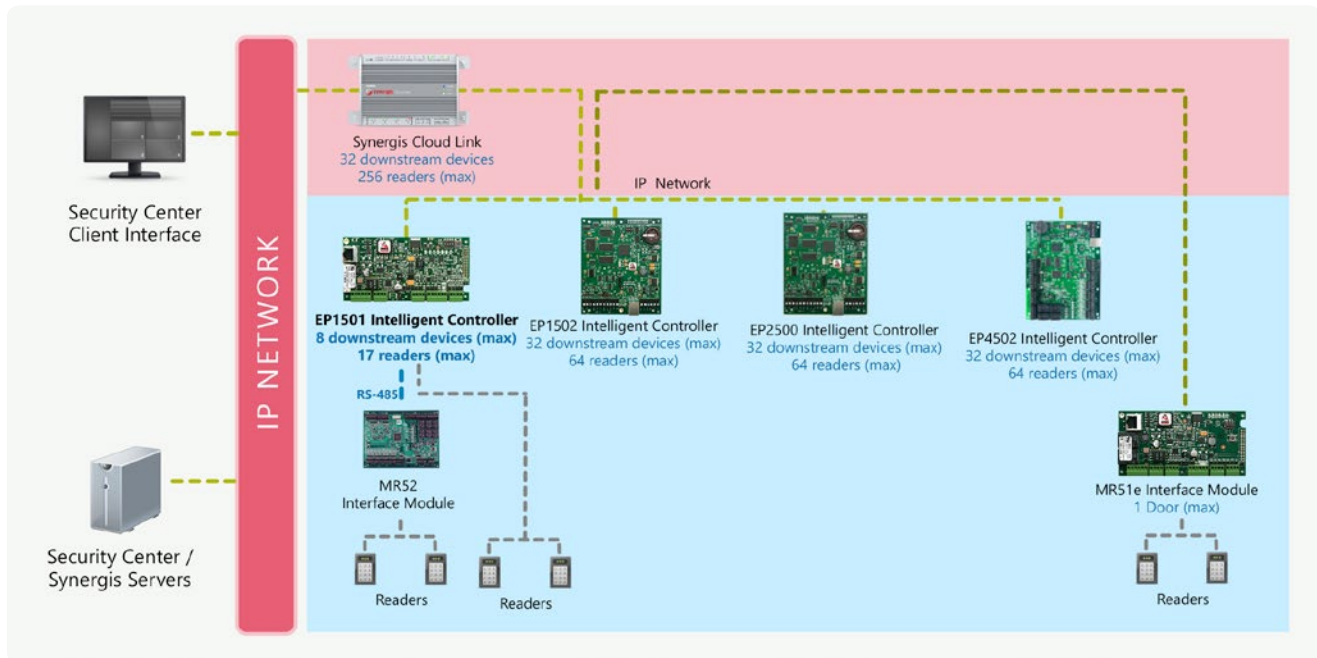

Genetec Inc.

2280 Alfred-Nobel Blvd., Suite 400,
Montreal, QC, Canada H4S 2A4

T 514.332.4000

genetec.com
info@genetec.com

© Genetec Inc., 2017. Genetec, Synergis, the Genetec Logo, and the Synergis Logo are trademarks of Genetec Inc., and may be registered or pending registration in several jurisdictions. Other trademarks used in this document may be trademarks of the manufacturers or vendors of the respective products.