



High Mount
Outdoor Detector
**HX-40/40AM/
40DAM**

WIRED MODEL

HX-40	2 PIRs standard model
HX-40AM	HX-40 with anti-masking
HX-40DAM	HX-40AM with micro-wave

FEATURES

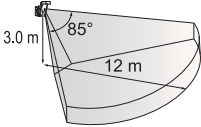

- 3.0 m high mount detection area (12 m)
- Unique pyro element
- Intelligent AND logic
- Dual signal processing logic
- Vegetation sway analysis logic
- Ideal detection area setting
- Digital anti-masking (AM/DAM model only)
- Microwave range selector (DAM model only)
- ETL certified for UL 639 and ULC S306

CONTENTS

1 INTRODUCTION			
1-1 BEFORE YOUR OPERATION	1	2-5 WALL TAMPER (OPTION)	6
1-2 PARTS IDENTIFICATION	2	3 WALK TEST	7
1-3 DETECTION AREA	3	4 SETTING	
2 INSTALLATION		4-1 FUNCTION	8
2-1 MOUNTING WITH THE BRACKET	3	5 AREA ADJUSTMENT	10
2-2 ADJUSTING THE VERTICAL ANGLE	5	6 LED INDICATION	10
2-3 MOUNTING WITHOUT THE BRACKET	5	7 SPECIFICATIONS	
2-4 WIRING	6	7-1 SPECIFICATIONS	11
		7-2 DIMENSIONS	11

1 INTRODUCTION

1-1 BEFORE YOUR OPERATION

Warning	Failure to follow the instructions provided with this indication and improper handling may cause death or serious injury.
Caution	Failure to follow the instructions provided with this indication and improper handling may cause injury and/or property damage.

The check mark indicates recommendation. The nix sign indicates prohibition.

<p>Warning</p> <p>Do not repair or modify product</p>	<p>Warning</p> <p>Keep product away from water</p>	<p>Caution</p> <p>Mount the unit securely</p>
<p>Mounting height.</p> <p>2.5 to 3.0 m (8.2 to 10 ft.)</p>	<p>Keep the detector parallel to the ground.</p> <p>Parallel</p> <p>Tilt</p>	<p>Consider the direction of the intruder, for the setting of the detection area.</p>

Install the detector in a place where it is free from false alarm factors. For example:

• Sunlight and reflection

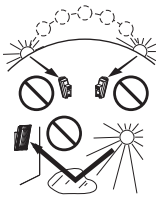

• Heat source

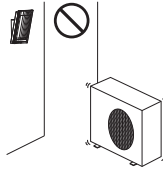

• Objects moving in the wind

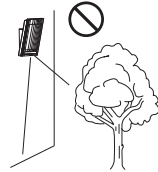

-Precautions for installing two or more sensors

HX-40
HX-40AM
HX-40DAM

Do not install two or more HX-40DAM's units side-by-side or face-to-face. Instead, install them back-to-back. If mounting on the same wall, be sure they are at least 1.0 m (3.3 ft.) apart from each other.

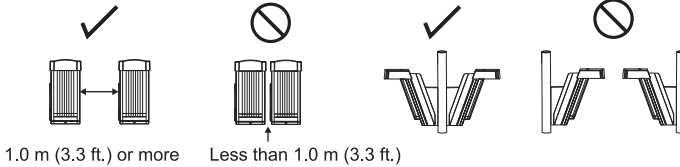

1-2 PARTS IDENTIFICATION

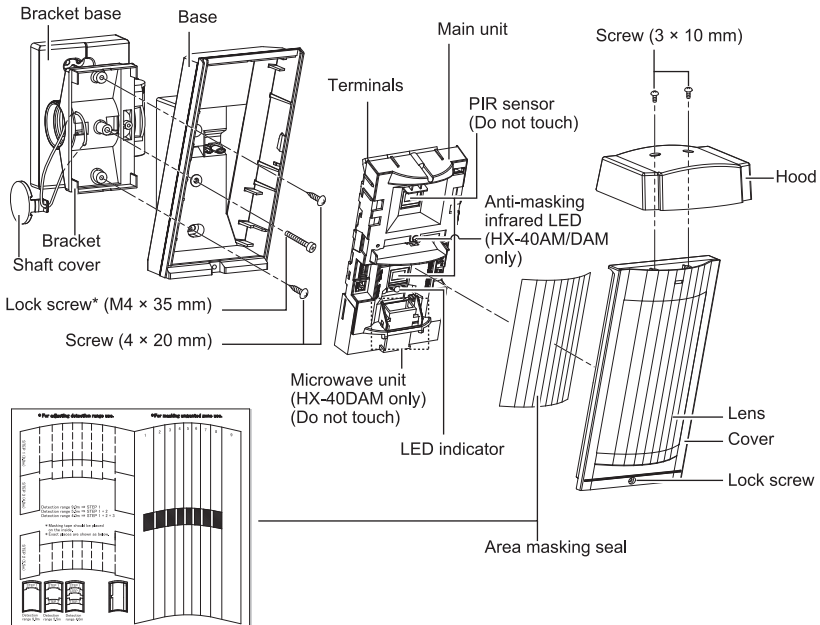

Screw kit

For joint	For wall mounting	For hood
Screw (4 x 20 mm)	Screw (4 x 20 mm)	Screw (3 x 10 mm)

*Lock screw attached on bracket base

Top view

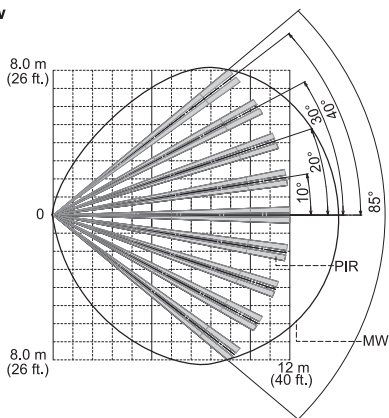

Side view (Mounting height: 3.0 m (10 ft.))

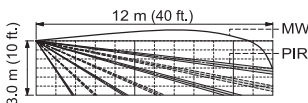

(Mounting height: 2.5 m (8.2 ft.))

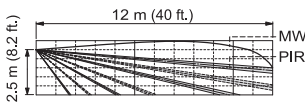

• Vertical angle: 1 click (2.5°) upward (Refer to "caution" in 2-2).

2 INSTALLATION

Use the bracket for normal installation. The unit may be mounted directly on the wall, without the bracket, only if the following three conditions are met;

- The mounting height 3.0 m (10 ft.).
- Horizontal direction adjustment is unnecessary.
- The ground is level.

2-1 MOUNTING WITH THE BRACKET

Using the bracket makes it possible to adjust the unit horizontally by $\pm 90^\circ$.

In cases where the ground is uneven and/or not parallel with the base of the unit, it is possible to adjust the unit vertically by $\pm 20^\circ$.

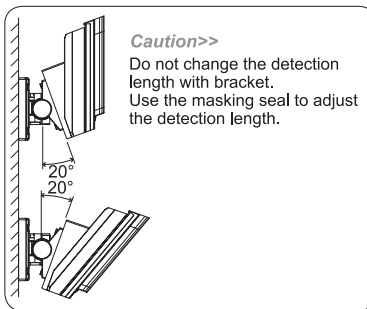
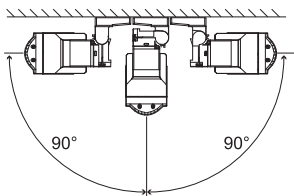

1 Remove the Up-Down lock screw.

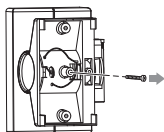

2 Push the shaft cover clip outwards to remove the shaft cover.

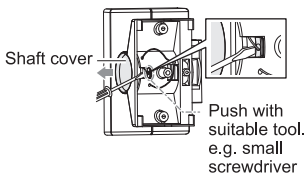

3 Loosen the adjustment screw two turns.

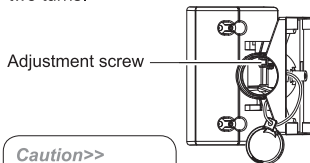

Caution>>
Do not loosen the screw too much. It may disassemble.

- 4 Tilt the bracket about 45° and pass through the wire.

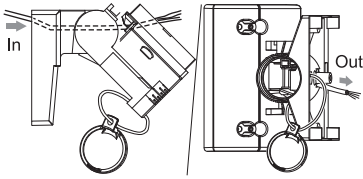

- 6 Open the wiring knockout.

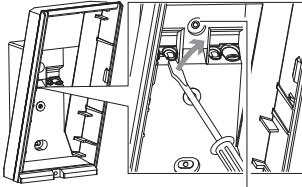

Wiring knockout

- 8 Tighten screws ① and ②, adjust the bracket angle (refer to 2-2), then tighten screw ③. Perform an area check. If re-adjustment is required, loosen screw 3 and change the bracket angle. After the adjustment is complete, tighten screw 3 again.

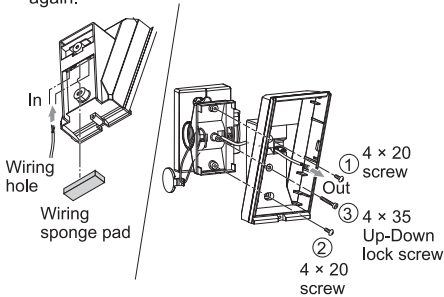

- 10 Wire to the terminal and install the main unit and lens on the base.

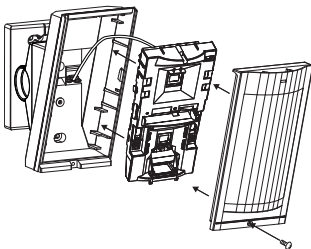

- 5 Determine the horizontal direction (left or right) of the detector before installing the bracket on the wall.

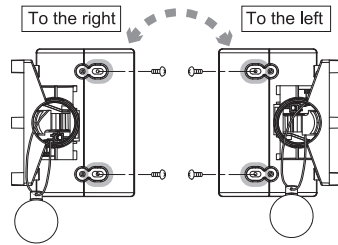

- 7 Open the Up-Down lock screw knockout for connecting the bracket.

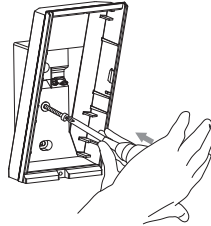

Knockout with 4 x 20 tapping screw (screwkit)

- 9 Tighten the adjustment screw clockwise.

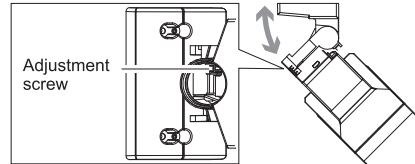

- 11 Install the shaft cover into place.

2-2 ADJUSTING THE VERTICAL ANGLE

For best performance, install detector parallel to the ground. Decide the detection length. If you choose 9.0 m/5.5 m/4.0 m, mask the unnecessary lens with masking seals.

Perform the walk test to check if detector is parallel to the ground.

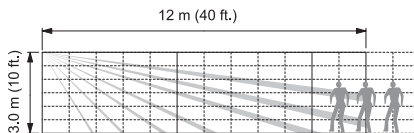

If the detection length is shorter than the designated one (refer to page 3), change the detector angle upward.

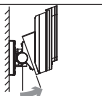

If the detection length is longer than the designated one (refer to page 3), change the detector angle downward.

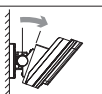

If the detection length is equal to the designated one, adjustments have been completed.

Caution>>

If the base of the unit is already parallel to the ground,
 • Do not change the detection length by tilting the unit up or down. Detection length should be adjusted with masking seal. Refer to 2-1 for the details.

Example (the ground is level)

0° is the right setting for 3.0 m (10 ft.) height installation.

Adjust 1 click (2.5° upward) for 2.5 m (8.2 ft.) height installation.

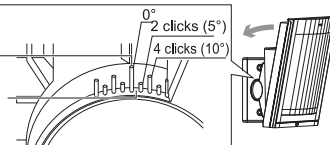

2-3 MOUNTING WITHOUT THE BRACKET

- 1 Open the wiring knockout with suitable tool e.g. screwdriver.

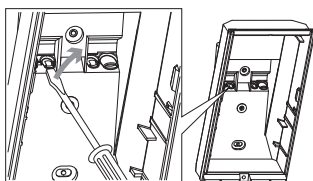

- 2 Pull the wire through the base knockout.

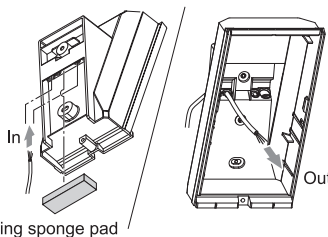

- 3 Fasten the base to the wall.

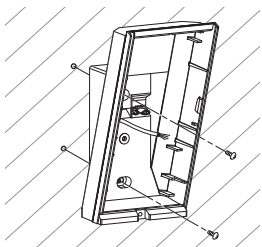

- 4 Install main unit after wiring to the terminal.

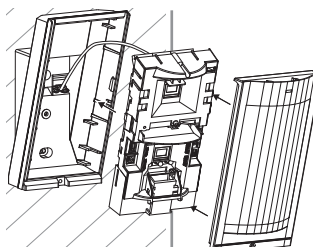

2-4 WIRING

Power wires should not exceed the following lengths.

Unit: m (ft.)

WIRE GAUGE	HX-40		HX-40AM		HX-40DAM	
	12 V	14 V	12 V	14 V	12 V	14 V
AWG22 (0.33 mm ²)	160 (520)	360 (1180)	140 (460)	310 (1020)	120 (390)	250 (820)
AWG20 (0.52 mm ²)	260 (850)	560 (1840)	230 (750)	490 (1610)	180 (590)	390 (1,280)
AWG18 (0.83 mm ²)	410 (1350)	900 (2950)	360 (1180)	780 (2560)	290 (950)	630 (2,070)

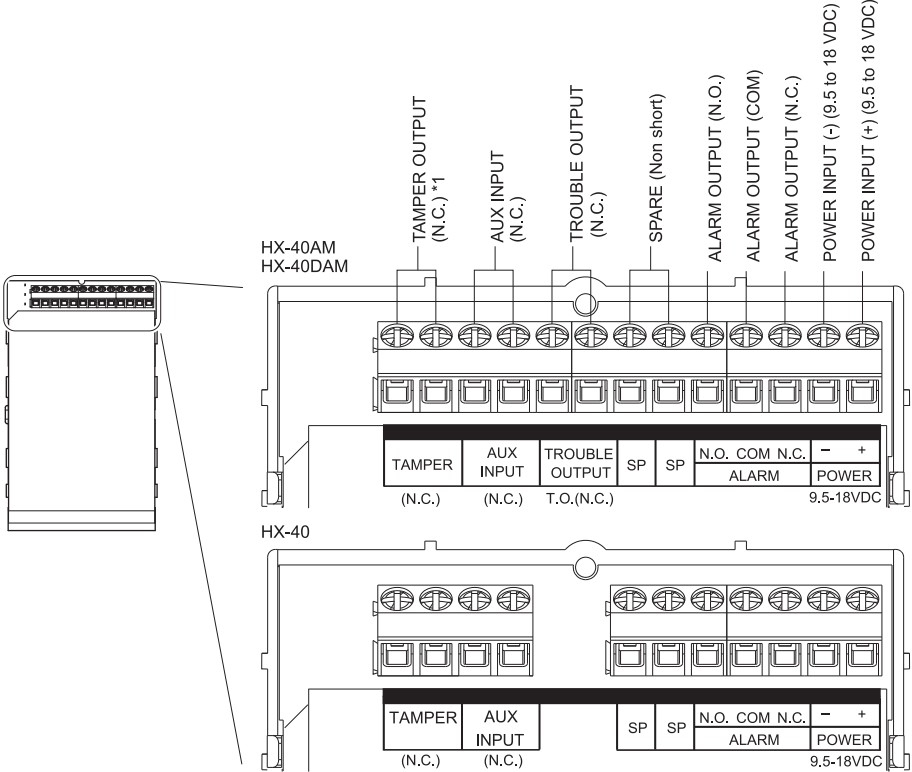

*1: TAMPER terminals to be connected to a 24 hour supervisory loop.

2-5 WALL TAMPER (OPTION)

Universal magnet switch may be mounted as a wall tamper.

Installation space for universal magnet switch is provided on the back of the main unit and the bracket.

Maximum size of an applicable universal magnet switch: D 9 x W 40 x H 9 mm (D 0.35 x W 1.57 x H 0.35 inches)

Universal magnet switch on the market assist is not included.

Main unit

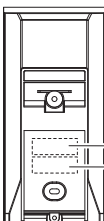

Magnet switch (Wall side)
installation position

Magnet switch (Base side)
installation position

Bracket

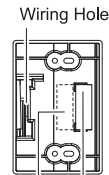

Magnet switch (Wall side)
installation position

Magnet switch (Bracket side)
installation position

-Installation

- 1 Install the universal magnet switch (wall side) to the wall. To determine the install position, use the "Install position template" provided on the inside cover of the product package.
- 2 Open the wiring knockout with suitable tool e.g. screwdriver.

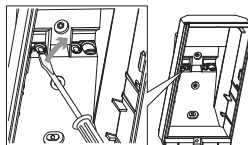
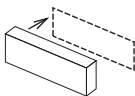

- 3 Install the other portion of the universal magnet switch to the back of the main unit or the bracket. Pull the wiring through the knockouts.

When not using the bracket

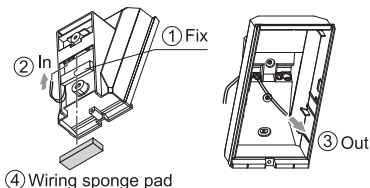

When using the bracket

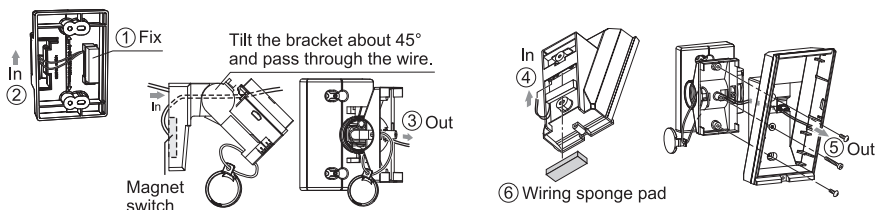

- 4 Install the bracket and the main unit to the wall surface.
- 5 Connect the universal magnet switch wiring to the tamper terminal of the main unit.

3 WALK TEST

- 1 Set the DIP switch 1 (LED ON/OFF) to "ON".
- 2 Check that the detector detects an object in the intended detection area. The installation has been successful if the LED lights for two seconds after a person walks into the detection area.
- 3 If the LED indication is not required at all times, set the DIP switch 1 (LED ON/ OFF) to "OFF".

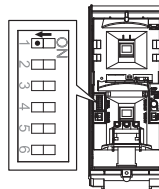
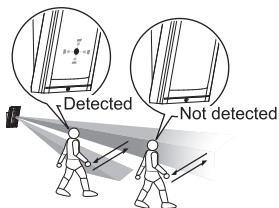
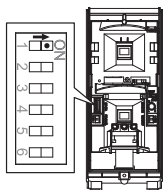

Note>>

The switch is set "ON" by factory default.

Note>>

- For the walk test, move more than 1.0 m (3.3 ft.) away from the detector.
- Conduct a walk test at least once a year.

4 SETTING

4-1 FUNCTION

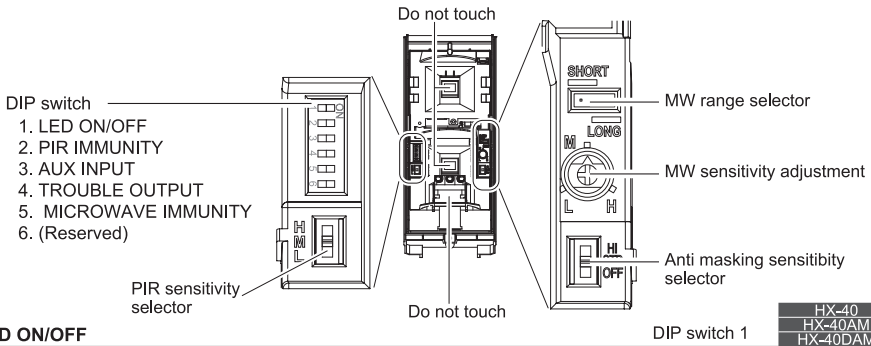

-LED ON/OFF



POSITION	FUNCTION
ON (Factory default)	The LED lights when someone is detected.
OFF	The LED does not light even if someone is detected.

HX-40
HX-40AM
HX-40DAM

DIP switch 1

-PIR IMMUNITY

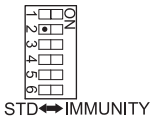

POSITION	FUNCTION
STD (Factory default)	PIR IMMUNITY logic is not activated.
IMMUNITY	PIR IMMUNITY logic is activated. Use this under harsh environment (e.g. small animal).

HX-40
HX-40AM
HX-40DAM

DIP switch 2

-AUX INPUT



POSITION	FUNCTION
AND (Factory default)	When both the main unit and the satellite detect someone, the alarm is output. Set to this when not connecting a satellite unit.
OR	When either the main unit or the satellite detects someone, the alarm is output.

HX-40
HX-40AM
HX-40DAM

DIP switch 3

By connecting a satellite unit (another warning sensor), you can extend the detection area and correct false alarms. As a satellite unit, you can use any general no-voltage contact output (NC) warning sensor, including the following. <Infrared (AIR) sensors, thermal line (PIR) sensors, universal magnet switches, etc.>

Notes>>

- The alarm does not output unless both the main unit and the satellite detect someone within 60 sec.
- If the OR mode is selected without a satellite unit connected, the alarm is generated continuously.

-TROUBLE OUTPUT

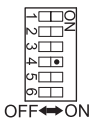

POSITION	FUNCTION
ON (Factory default)	Anti-masking signal is output from TROUBLE OUTPUT terminal.
OFF	Anti-masking signal is output from both TROUBLE and ALARM OUTPUT terminal.

HX-40
HX-40AM
HX-40DAM

DIP switch 4

Trouble output is used for anti-masking signal. When an object is placed close to the lens surface, for a period of more than 180 sec., the IR Anti-Masking circuit is activated and generates a trouble signal.

Notes>>

Use this when not wiring a detected trouble input terminal on the control panel.

-MICROWAVE IMMUNITY

DIP switch 5

HX-40
HX-40AM
HX-40DAM













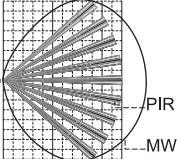

STD ↔ IMMUNITY

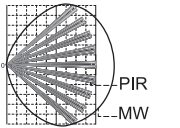
POSITION	FUNCTION
STD (Factory default)	MICRO WAVE IMMUNITY logic is not activated.
IMMUNITY	MICRO WAVE IMMUNITY logic is activated. Use this under harsh environment (e.g. vegetation sway).

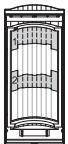
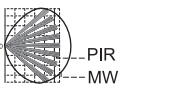
**RANGE SELECTOR/
SENSITIVITY
ADJUSTMENT**

HX-40
HX-40AM
HX-40DAM

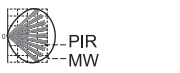
-MW RANGE SELECTOR/MW SENSITIVITY ADJUSTMENT

PIR AREA SETTING	DETECTION AREA (SIDE VIEW)	MW RANGE SELECTOR	MW SENSITIVITY ADJUSTMENT
12 m (40 ft.)  Factory default		LONG 	MID 
9.0 m (30 ft.) 		SHORT 	HIGH 
5.5 m (18 ft.) 		SHORT 	MID 
4.0 m (13 ft.) 		SHORT 	LOW 

-PIR SENSITIVITY

PIR SENSITIVITY SELECTOR

HX-40
HX-40AM
HX-40DAM

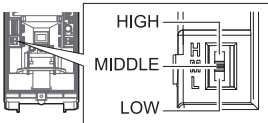

POSITION	FUNCTION
HIGH	High sensitivity
MIDDLE (Factory default)	Middle sensitivity
LOW	Low sensitivity

-ANTI-MASKING SENSITIVITY

ANTI-MASKING SENSITIVITY SELECTOR

HX-40
HX-40AM
HX-40DAM

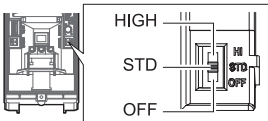

POSITION	FUNCTION
HIGH	High sensitivity
STD (Factory default)	Standard sensitivity
OFF	Disabled

Caution>>

When closing the cover, do not leave any object within 1.0 m (3.3 ft.) from the unit.

ENGLISH

FRANÇAIS

DEUTSCH

ITALIANO

ESPAÑOL

PORTUGUÊS

5 AREA ADJUSTMENT

-DETECTION LENGTH ADJUSTMENT

To limit the detection length, apply the appropriate masking seal. Note that there are three different types of seal.

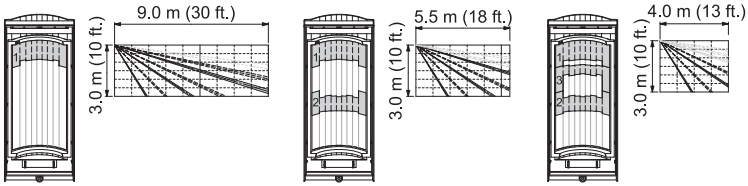

-AREA MASKING

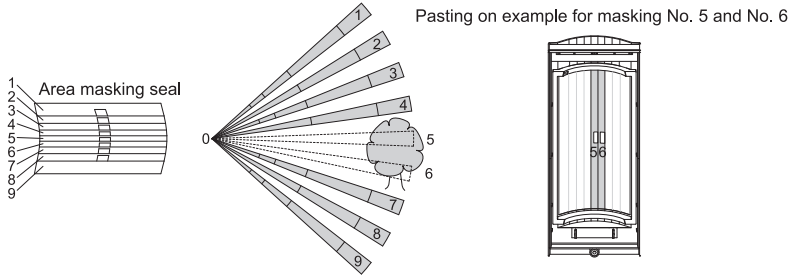

Pasting on example for masking No. 5 and No. 6

6 LED INDICATION

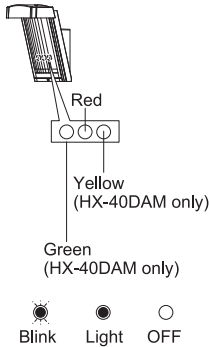

-HX-40/40AM

DETECTOR CONDITION		LED INDICATOR (RED ONLY)
Warm-up		→ Blinks for approx. 60 sec.
Alarm		→ Lights for 2 sec.
Trouble output	Anti-Masking booting (Anti-Masking start up)	→ → → Blinks 2 times and goes off for 5 sec. and then repeats for 180 sec.
	Masking detection	→ → → → Blinks 3 times and goes off for 3 sec. and then repeats.

-HX-40DAM

DETECTOR CONDITION		LED INDICATOR
Warm-up		→ → Blinks for approx. 60 sec.
Alarm		→ → Red lights for 2 sec.
PIR detection		→ → Green lights for 2 sec.
MW detection		→ → Yellow lights for 2 sec.
Trouble output	Anti-Masking booting (Anti-Masking start up)	→ → → → → Green and Red blink 2 times simultaneously and go off for 5 sec. This sequence is repeated for 180 sec.
	Masking detection	→ → → → → Green and Red blink 3 times simultaneously and go off for 3 sec. This sequence is repeated.

7 SPECIFICATIONS

ENGLISH

FRANÇAIS

DEUTSCH

ITALIANO

ESPAÑOL

PORTUGUÊS

7-1 SPECIFICATIONS

Model	HX-40	HX-40AM	HX-40DAM
Detection method	Passive infrared		Passive infrared & Microwave
PIR Coverage	12 m (40 ft.) 85° wide / 94 zones		
PIR distance limit	4.0 m, 5.5 m, 9.0 m (13 ft., 18 ft., 30 ft.)		
Detectable speed	0.3 m/s to 1.5 m/s (1 ft./s to 5 ft./s)		
Sensitivity	2.0°C (3.6°F) at 0.6 m/s		
Power input	9.5 to 18 VDC		
Current draw	35 mA (max.) at 12 VDC	40 mA (max.) at 12 VDC	50 mA (max.) at 12 VDC
Alarm period	2.0 ±1 sec.		
Warm-up period	Approx. 60 sec. (LED blinks)		
Alarm output	Form C 28 VDC 0.2 A (max.)		
Tamper output	N.C. 28 VDC, 0.1 A (max.) N.C. open when cover removed.		
Trouble output	-		
Aux input	N.C. 28 VDC, 0.1 A (max.)		
LED indicator	Red: Warm-up, Alarm	Red: Warm-up, Alarm, Trouble	Red: Warm-up, Alarm, Trouble Green: Warm-up, PIR detect, Trouble Yellow: Warm-up, MW detect
Operating temperature	-20°C to +60°C (-4°F to +140°F)		
Environment humidity	95% max.		
Weatherproof	IP55		
Mounting	Wall		
Mounting height	2.5 to 3.0 m (8.2 to 10 ft.)		
Bracket adjust angle	Vertical: ±20° Horizontal: ±95°		
Weight	600 g (21.2 oz.)		700 g (24.7 oz.)
Accessories	Bracket, Hood, Area masking seal. Screw (3 × 10 mm) × 2, Screw (4 × 20 mm) × 4		

* Specifications and designs are subject to change without prior notice.

7-2 DIMENSIONS

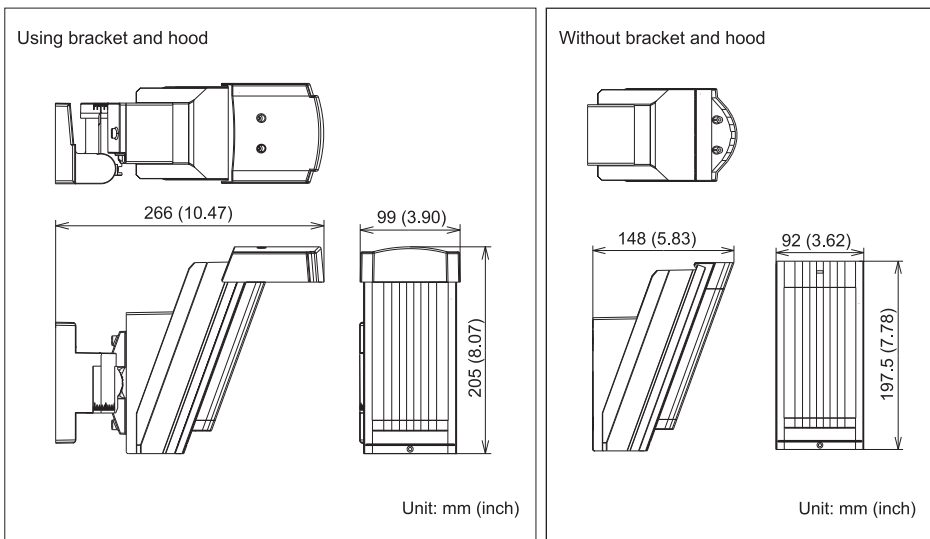

**OPTEX INC. (U.S.)**URL: <http://www.optexamerica.com/>**OPTEX DO BRASIL LTDA. (Brazil)**URL: <http://www.optex.net/br/es/sec/>**OPTEX (EUROPE) LTD. / EMEA HQ (U.K.)**URL: <http://www.optexeurope.com/>**OPTEX CO., LTD. (JAPAN)**URL: <http://www.optex.net/>**OPTEX TECHNOLOGIES B.V.
(The Netherlands)**URL: <http://www.optex.eu/>**OPTEX SECURITY SAS (France)**URL: <http://www.optex-security.com/>**OPTEX SECURITY Sp.z o.o. (Poland)**URL: <http://www.optex.com.pl/>**OPTEX PINNACLE INDIA, PVT., LTD. (India)**URL: <http://www.optex.net/in/en/sec/>**OPTEX KOREA CO.,LTD. (Korea)**URL: <http://www.optexkorea.com/>**OPTEX (DONGGUAN) CO.,LTD.
SHANGHAI OFFICE (China)**URL: <http://www.optexchina.com/>

Détecteur extérieur pour montage en hauteur
HX-40/40AM/40DAM **MODELE FILAIRE**

HX-40	Modèle standard 2 PIRs
HX-40AM	HX-40 avec anti-masquage
HX-40DAM	HX-40AM avec hyperfréquences

CARACTERISTIQUES

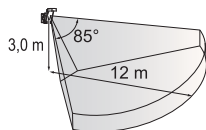

- Montage à 3,0 m de hauteur, zone de détection (12 m)
- Nouveau Pyro-élément
- Intelligent AND Logique
- Logique d'ajustement automatique de la sensibilité
- Logique d'analyse de la végétation
- Réglage de la zone de détection
- Anti-masquage numérique (pour modèle AM/DAM uniquement)
- Réglage de la portée d'hyperfréquence (pour modèle DAM uniquement)
- Certifié ETL pour UL639 et ULC S306

SOMMAIRE

1 INTRODUCTION			
1-1 AVANT L'INSTALLATION	1	2-5 AUTOPROTECTION DU MUR (OPTION)	6
1-2 IDENTIFICATION DES PIÈCES	2	3 TEST DE MARCHÉ	7
1-3 ZONE DE DÉTECTION	3	4 REGLAGE	
2 INSTALLATION		4-1 FONCTION	8
2-1 MONTAGE DE LA ROTULE	3	5 REGLAGE DE ZONE	10
2-2 REGLAGE DE L'ANGLE VERTICAL	5	6 VOYANT LED	10
2-3 INSTALLATION SANS ROTULE	5	7 SPECIFICATIONS	
2-4 CABLAGE	6	7-1 SPECIFICATIONS	11
		7-2 DIMENSIONS	11

1 INTRODUCTION

1-1 AVANT L'INSTALLATION

Avertissement	Le non respect des instructions suivantes ou une manipulation inappropriée peut provoquer la mort ou blesser quelqu'un.
Attention	Le non respect des instructions suivantes ou une manipulation inappropriée peut provoquer des dommages aux personnes et/ou aux biens.

Le signe coche indique une recommandation. Le signe non indique une interdiction.

<p> Avertissement</p> <p>Ne pas réparer ou modifier le produit</p>	<p> Avertissement</p> <p>Tenir le produit éloigné de l'eau</p>	<p> Attention</p> <p>Monter l'unité en sécurité</p>
<p>Hauteur de montage.</p> <p>Entre 2,5 et 3,0 m (Entre 8,2 et 10 ft.)</p>	<p>Maintenir le détecteur parallèle au sol.</p> <p>Parallèle</p> <p>Ne pas incliner</p>	<p>Prendre en compte la direction d'où vient la personne qui s'approche ainsi que la zone de détection.</p>

Installer le détecteur dans un emplacement ne présentant pas de cause de fausses alarmes. Par exemple:

• Lumière solaire et réflexion

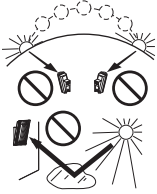

• Source de chaleur

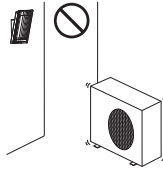

• Objet balancé par le vent

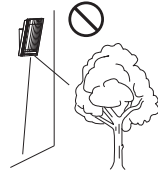

-Consignes pour l'installation de plusieurs détecteurs

HX-40
HX-40AM
HX-40DAM

Ne pas installer deux détecteurs HX-40DAM côte à côte ou face à face. Les installer dos à dos en respectant une distance minimum de 1,0 m (3,3 ft.) s'ils sont fixés sur un même mur.

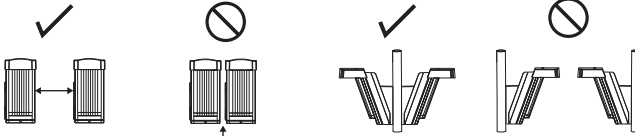

Plus de 1,0 m (3,3 ft.)

Moins de 1,0 m (3,3 ft.)

1-2 IDENTIFICATION DES PIÈCES

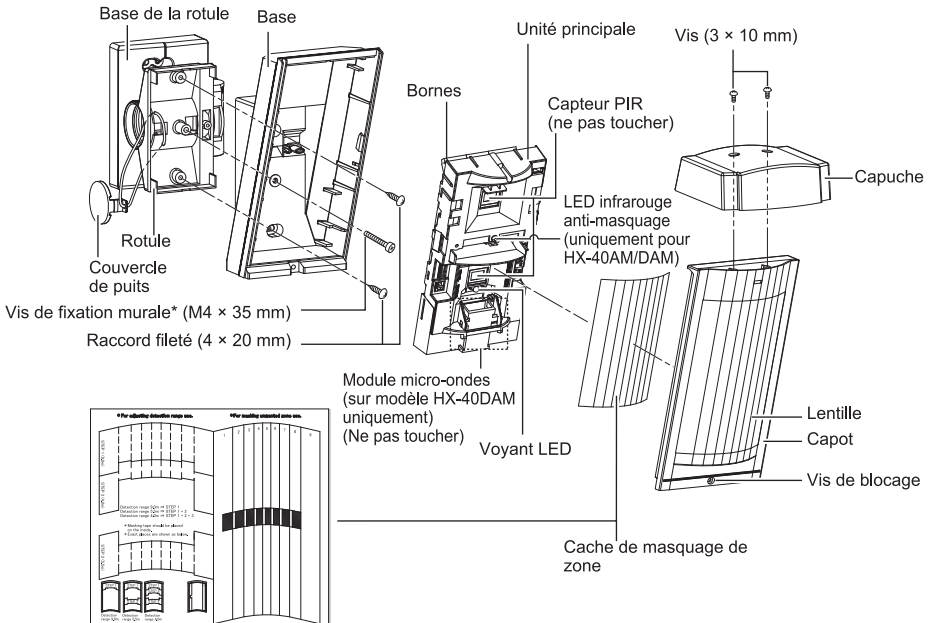

Vis	Pour raccord	Pour montage au mur	Pour le capot
Vis (4 x 20 mm)	Vis (4 x 20 mm)	Vis (4 x 20 mm)	Vis (3 x 10 mm)

*Vis de blocage attachée à la base de la rotule

Vue de dessus

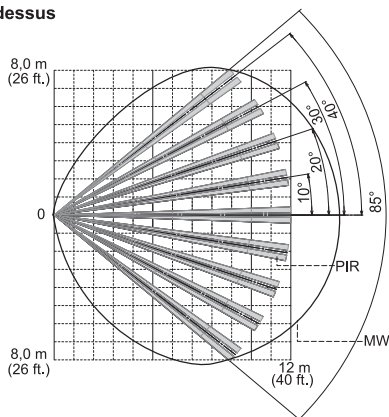

Vue de coté (Hauteur d'installation 3,0 m (10 ft.))

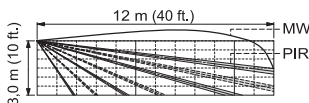

(Hauteur d'installation 2,5 m (8,2 ft.))

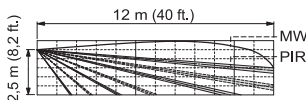

• Angle vertical : 1 cliquet (2,5°) vers le haut (Voir "Attention" au chapitre 2-2)

2 INSTALLATION

Utiliser la rotule pour une installation normale. L'appareil peut être installé directement sur le mur, sans la rotule, uniquement si les trois conditions suivantes sont réunies :

- La hauteur de montage 3 m (10 ft.).
- Aucun réglage horizontal n'est nécessaire.
- Le sol est plat.

2-1 MONTAGE DE LA ROTULE

L'utilisation de la rotule permet le réglage horizontal de plus/moins 90 degrés.

Si le sol est inégal et donc non parallèle à la base de l'unité, on peut régler l'unité verticalement de plus/moins 20 degrés.

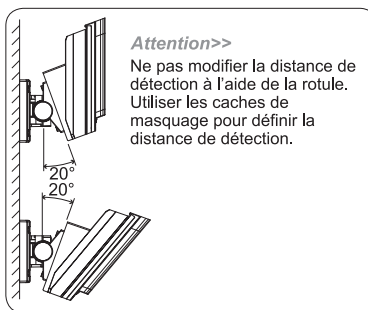
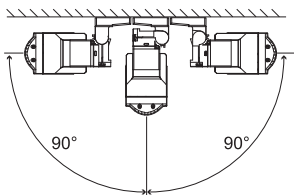

Attention>>

Ne pas modifier la distance de détection à l'aide de la rotule. Utiliser les caches de masquage pour définir la distance de détection.

1 Retirer la vis de blocage haut-bas.

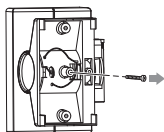

2 Pousser l'appui de couvercle de puits tout droit pour retirer le couvercle de puits.

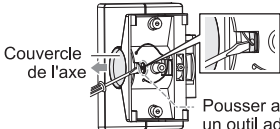

Pousser avec un outil adapté, par ex. un petit tournevis

3 Desserrer la vis de réglage de deux tours.

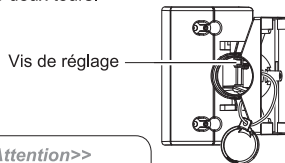

Attention>>

Ne pas trop desserrer, la vis peut se séparer du bloc.

- 4 Incliner la rotule à 45° et enfiler le câble.

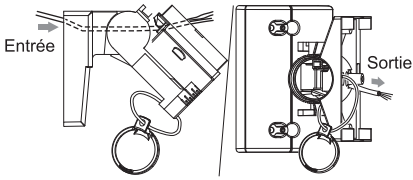

- 6 Défoncer le pré-perçage de câble.

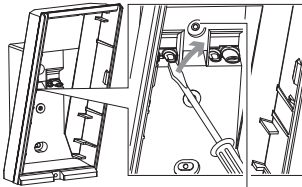

Pré-perçage de câble.

- 8 Serrer les vis ① et ② puis régler l'angle de la rotule (voir 2-2) avant de serrer la vis ③. Effectuer une vérification de zone. Si un réajustement est nécessaire, desserrer la vis ③ et modifier l'angle de la rotule. Une fois l'ajustement effectué, resserrer la vis ③.

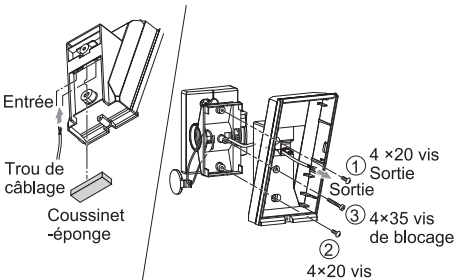

- 10 Connecter au bornier et fixer l'unité principale et la lentille à la base.

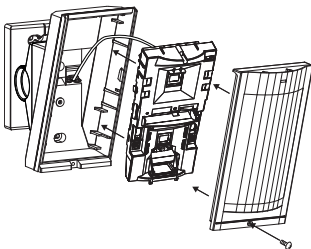

- 5 Déterminer la direction horizontale (gauche ou droite) du détecteur avant de fixer la rotule au mur.

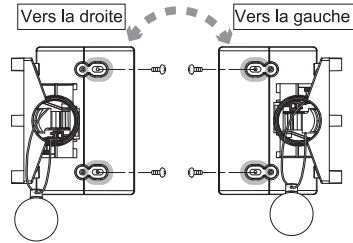

- 7 Défoncer le pré-perçage de la vis de blocage pour le support.

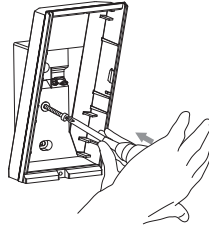

Pré-perçage avec 4 vis taraudeuses de 20 (kit de fixation)

- 9 Serrer la vis de réglage dans le sens horaire.

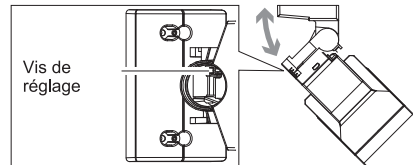

- 11 Mettre le couvercle de puits à sa place.

2-2 REGLAGE DE L'ANGLE VERTICAL

Pour obtenir une meilleure performance, installer le détecteur parallèle au sol.
Choisir la distance de détection. Selon la distance 9,0 m/5,5 m/4,0 m, masquer les zones non utiles de la lentille à l' aide des caches de masquage.

Effectuer un test de marche pour vérifier que le détecteur est parallèle au sol.

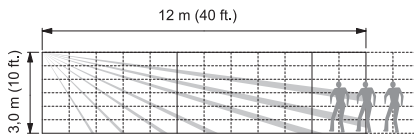

* Exemple pour une plage de détection de 12 m.

Si la distance de détection est plus courte que celle réglée au préalable (voir page 3), modifier l'angle du détecteur vers le haut.

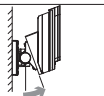

Si la distance de détection est plus longue que celle réglée au préalable (voir page 3), modifier l'angle du détecteur vers le bas.

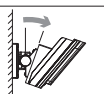

Si la distance de détection souhaitée correspond, les réglages sont terminés.

Attention>>

Si la base du détecteur est déjà parallèle au sol,

• Ne pas modifier la zone de détection en pivotant l' appareil vers le haut ou vers le bas. La zone de détection doit être réglée à l' aide des caches de masquage. Voir 2-1 pour plus d' informations.

Exemple (le sol est nivelé)

0° est le réglage correct pour une installation à 3,0 m (10 ft.) de hauteur.

Ajuster de 1 cliquet (2,5 degrés vers le haut) pour 2,5 m (8,2 ft.) de hauteur d'installation.

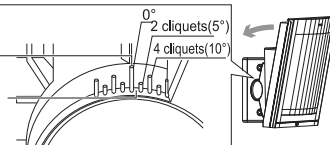

2-3 INSTALLATION SANS ROTULE

- 1 Déboucher le pré-perçage du câblage à l'aide d'un outil adapté e.g. un petit tournevis.

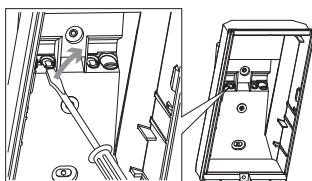

- 2 Tirer les câbles à travers les préperçages.

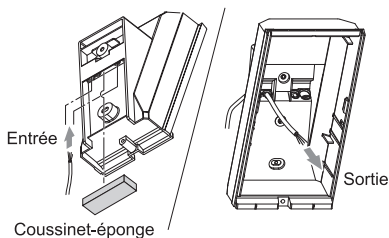

- 3 Fixer la base au mur.

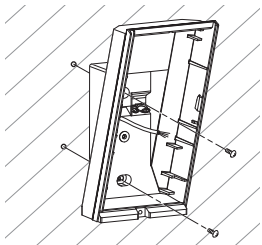

- 4 Installer l' unité principale après l' avoir câblé au bornier.

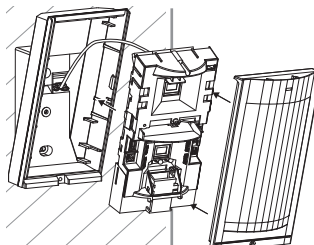

2-4 CABLAGE

Les câbles d'alimentation ne doivent pas dépasser les longueurs suivantes :

Unité : mètre (pied)

Épaisseur de fil	HX-40		HX-40AM		HX-40DAM	
	12 V	14 V	12 V	14 V	12 V	14 V
AWG22 (0,33 mm ²)	160 (520)	360 (1180)	140 (460)	310 (1020)	120 (390)	250 (820)
AWG20 (0,52 mm ²)	260 (850)	560 (1840)	230 (750)	490 (1610)	180 (590)	390 (1280)
AWG18 (0,83 mm ²)	410 (1350)	900 (2950)	360 (1180)	780 (2560)	290 (950)	630 (2070)

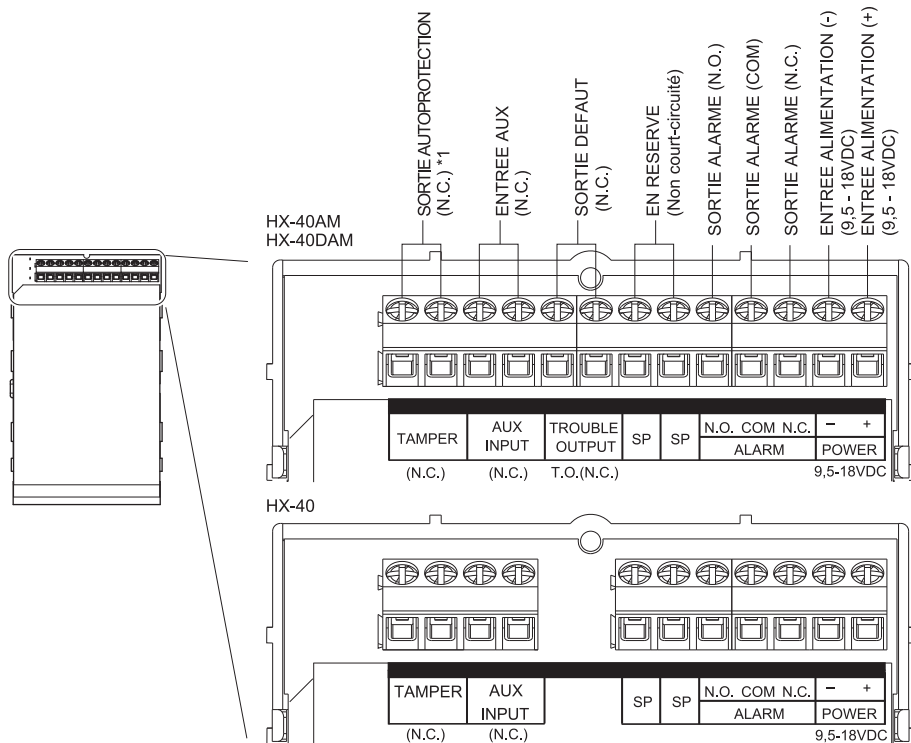

*1: Bornes AUTOPROTECTION à raccorder à une boucle de supervision de 24 heures.

2-5 AUTOPROTECTION DU MUR (OPTION)

Un commutateur magnétique peut être monté pour l'autoprotection du mur.

Un espace pour l'installation du commutateur magnétique universel est disponible au dos de l'unité principale et de la rotule. Taille maximum d'un commutateur magnétique universel utilisable : D 9 x W 40 x H 9 mm (D 0.35 x W 1.57 x H 0.35 inches) Le commutateur magnétique n'est pas fourni.

Bloc principal



emplacement du contact magnétique (côté mur)

emplacement du contact magnétique (côté rotule)

Rotule

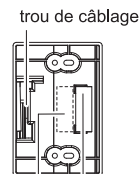

emplacement du contact magnétique (côté mur)

emplacement du contact magnétique (côté rotule)

-Installation

- 1 Installer le commutateur magnétique (côté mur) au mur. Se servir du modèle d'emplacement présent au dos de l'emballage du produit pour déterminer l'emplacement de l'installation.
- 2 Dé boucher le pré-perçage du câblage à l'aide d'un outil adapté e.g. un petit tournevis.

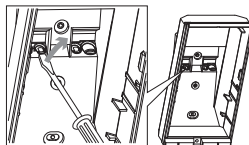
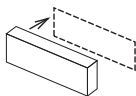

- 3 Installer l'autre moitié du contact magnétique au dos du bloc principal ou de la rotule. Faire passer les câbles à travers les pré-perçages.

Sans utilisation de la rotule

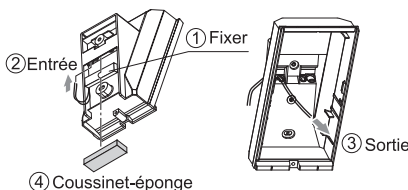

Avec utilisation de la rotule

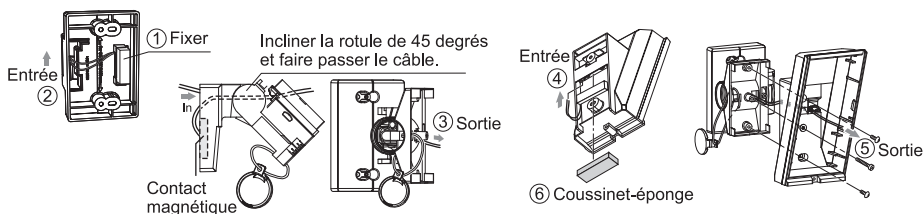

- 4 Installer la rotule et le bloc principal au mur.
- 5 Raccorder le contact magnétique au bornier d'autoprotection du bloc principal.

3 TEST DE MARCHÉ

- 1 Positionner l'interrupteur DIP 1 sur ON (Test).
- 2 Vérifier qu'un objet est détecté dans la zone de détection testée. L'installation est réussie si la LED s'allume 2 secondes après qu'une personne marche dans la zone de détection.
- 3 Si la LED ne nécessite pas d'être allumée en permanence, positionner l'interrupteur DIP 1 (LED ON/OFF) sur OFF.

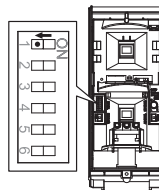
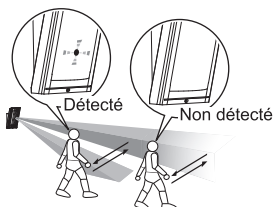
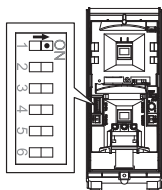

Remarque>>

L'interrupteur est en position "ON" par défaut.

Remarque>>

- Pour le test de marche, se placer à plus de 1,0 m (3,3 ft.) du détecteur.
- Exécuter un test de marche au moins une fois par an.

4 REGLAGE

4-1 FONCTION

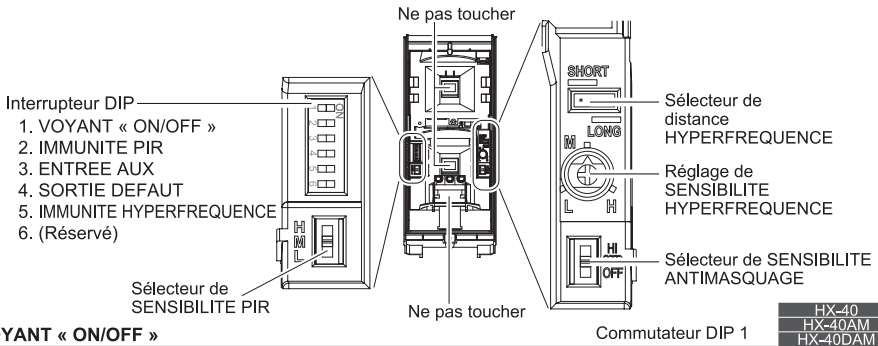

HX-40
 HX-40AM
 HX-40DAM

-VOYANT « ON/OFF »



POSITION	FONCTION
ON (Réglage d'usine par défaut)	Le voyant s'allume en cas de d'étection.
OFF	Le voyant ne s'allume pas en cas de détection.

-PIR IMMUNITY

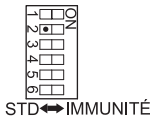

POSITION	FONCTION
STD (Réglage d'usine par défaut)	La fonction d'immunité n'est pas activée.
IMMUNITÉ	La fonction d'immunité est activée. À utiliser dans un environnement hostile (ex. présence de petits animaux).

-ENTRÉE AUXILIAIRE

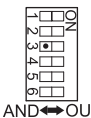

POSITION	FONCTION
ET (Réglage d'usine par défaut)	Lorsque les deux détecteurs, principal et satellite, détecte la présence d'un intrus, l'alarme se déclenche. Régler sur cette position si un détecteur satellite n'est pas raccordé.
OU	Si l'un des deux détecteurs, principal ou satellite, détecte la présence d'un intrus l'alarme se déclenche.

Remarque>>

- L'alarme s'enclenche uniquement si les deux unités s'activent au cours d'une durée de 60 secondes.
- En cas du mode OK, l'alarme reste déclencher, si le deuxième détecteur n'est pas présent.

-SORTIE « DÉFAUT »

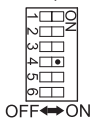

POSITION	FONCTION
ON (Réglage d'usine par défaut)	Le signal d'anti-masquage est issu de la borne de sortie « Défaut ».
OFF	Le signal est issu des deux bornes de sortie « Défaut » et « Alarme ».

Remarque>>

Utiliser cette position si une borne d'entrée de défaut n'est pas raccordée au panneau de contrôle.

-IMMUNITÉ MICRO-ONDES

Commutateur DIP 5

HX-40
HX-40AM
HX-40DAM



POSITION	FONCTION
STD (Réglage d'usine par défaut)	La fonction IMMUNITÉ HYPERFREQUENCE n'est pas activée.
IMMUNITÉ	La fonction IMMUNITÉ HYPERFREQUENCE est activée. A utiliser cette position dans un environnement difficile (e.g. ondulation des végétaux)

-SELECTEUR DE DISTANCE/REGLAGE SENSIBILITE HYPERFREQUENCE

SELECTEUR DE DISTANCE /REGLAGE SENSIBILITE

HX-40
HX-40AM
HX-40DAM

Réglage de zone PIR	Zone de détection (vue de côté)	Selecteur de distance hyperfréquence	Réglage sensibilité hyperfréquent
12 m (40 ft.) Réglage d'usine par défaut		LONGUE LONGUE BASSE	MOYENNE
9,0 m (30 ft.)		BASSE LONGUE BASSE	HAUTE
5,5 m (18 ft.)		BASSE LONGUE BASSE	MOYENNE
4,0 m (13 ft.)		BASSE LONGUE BASSE	BASSE

-SENSIBILITE PIR

Selecteur de SENSIBILITE PIR

HX-40
HX-40AM
HX-40DAM

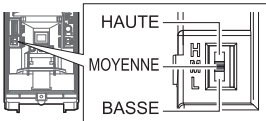

POSITION	FONCTION
HAUTE	Sensibilité élevée
MOYENNE (réglage d'usine)	Sensibilité moyenne
BASSE	Sensibilité basse

-SENSIBILITE ANTI-MASQUAGE

Selecteur de SENSIBILITE ANTI-MASQUAGE

HX-40
HX-40AM
HX-40DAM

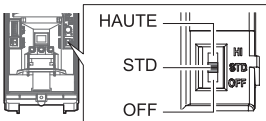

POSITION	FONCTION
HAUTE	Sensibilité élevée
STD (réglage d'usine)	Sensibilité normale
OFF	Désactivé

Attention>>>

Après avoir fermé le couvercle, ne laisser aucun objet à moins 1,0 m (3,3 ft.) de l'unité.

5 REGLAGE DE ZONE

-Réglage de la distance de détection

Pour limiter la portée de détection, appliquer le cache de masquage approprié. Il y a trois types de caches différents.

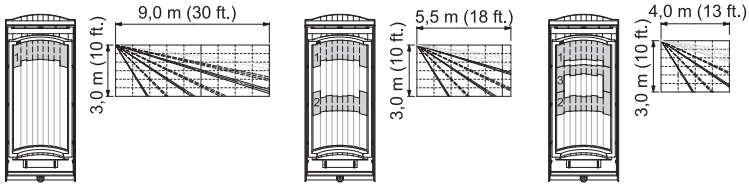

-ZONE MASQUEE

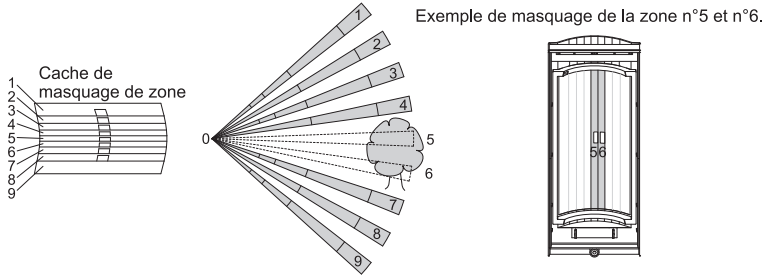

6 VOYANT LED

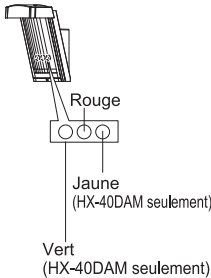

Clignote
 Lumière
 OFF

-HX-40/40AM

CONDITION DU DETECTEUR		INDICATEUR LED (ROUGE UNIQUEMENT)
Période de chauffe		→ Clignote pendant environ 60 secondes.
Alarme		→ Lumière pendant 2 secondes.
Sortie défaut	Boot de l'Anti-Masquage (Démarrage Anti-Masquage)	→ → → Clignote 2 fois, s'éteint pendant 5 s puis la séquence se répète pendant 180 s.
	Détection de masquage	→ → → Clignote 3 fois, s'éteint pendant 3 s et la séquence se répète

-HX-40DAM

CONDITION DU DETECTEUR		INDICATEUR LED
Période de chauffe		→ → Clignote pendant environ 60 secondes.
Alarme		→ → Rouge lumière pendant 2 secondes.
Détection PIR		→ → Vert lumière pendant 2 secondes.
Détection hyperfréquence		→ → Jaune lumière pendant 2 secondes.
Sortie défaut	Boot de l'Anti-Masquage (Démarrage Anti-Masquage)	→ → → Les voyants vert et rouge clignotent 2 fois, s'éteignent pendant 5 s et la séquence se répète pendant 180 s.
	Détection de masquage	→ → → Les voyants vert et rouge clignotent 3 fois, s'éteignent pendant 3 s et la séquence se répète.

7 SPECIFICATIONS

ENGLISH

FRANÇAIS

DEUTSCH

ITALIANO

ESPAÑOL

PORTUGUÊS

7-1 SPECIFICATIONS

Modèle	HX-40	HX-40AM	HX-40DAM
Méthode de détection	Infrarouge passif		Infrarouge passif et hyperfréquence
Couverture PIR	12 m (40 ft.) sur 85° / 94 zones		
Distances limites PIR	4,0 m, 5,5 m, 9,0 m (13 ft., 18 ft. 30 ft.)		
Vitesse détectable	0,3 m/s – 1,5 m/s (1 ft./s – 5 ft./s)		
Sensibilité	2,0°C (3,6°F) (à 0,6 m/s)		
Alimentation	9,5 – 18 VDC		
Consommation de courant	35 mA (max.) à 12 VDC	40 mA (max.) à 12 VDC	50 mA (max.) à 12 VDC
Période d'alarme	2,0 ±1 sec.		
Période de chauf	Approx. 60 sec. (la LED clignote)		
Sortie alarme	Contact forme C 28 VDC 0,2A (max.)		
Sortie autoprotection	Form C. 28 VDC, 0,1 A (max.), active quand le capot est enlevé.		
Sortie défaut	– N.C. 28 VDC, 0,1 A (max.)		
Entrée Aux	N.C. 28 VDC, 0,1 A (max.)		
Indications LED	Rouge : démarrage, mode alarme	Rouge : démarrage, mode alarme, défaut	Rouge : démarrage, mode alarme, défaut Vert : démarrage, détection PIR, défaut Jaune : démarrage, détection hyperfréquence (MW)
Température de fonctionnement	-20 – +60°C (-4 – +140°F)		
Humidité	95% max.		
Étanche	IP55		
Montage	Sur mur		
Hauteur de montage	2,5 – 3,0 m (8,2 – 10 ft.)		
Rotule d'ajustement	Vertical: ±20° Horizontal: ±95°		
Poids	600 g (21,2 oz.)		700 g (24,7 oz.)
Accessoires	Rotule, capot, cache de masquage, vis (3 × 8 mm) × 2, vis (4 × 20 mm) × 4		

* Les spécifications et le design peuvent être modifiés sans préavis.

7-2 DIMENSIONS

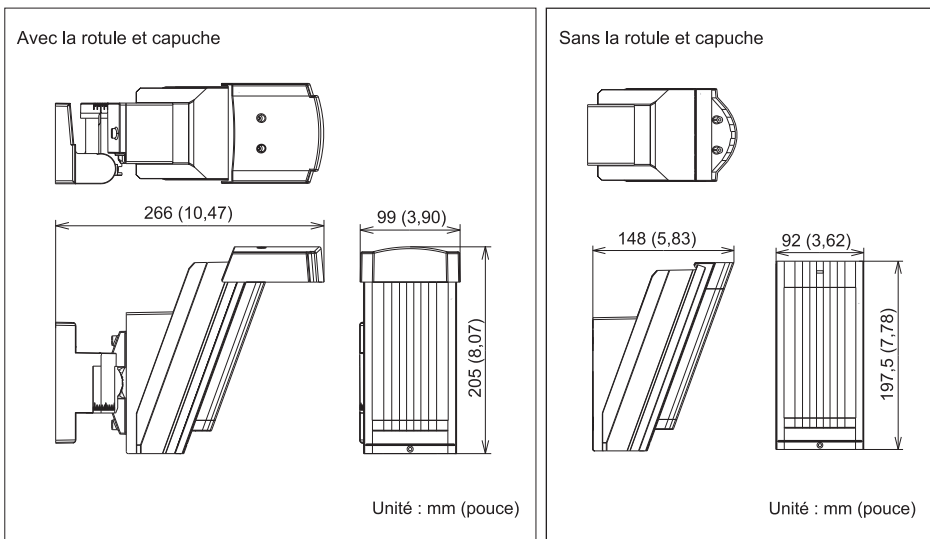

**OPTEX CO., LTD. (JAPAN)**URL: <http://www.optex.net/>**OPTEX INC. (U.S.)**URL: <http://www.optexamerica.com/>**OPTEX DO BRASIL LTDA. (Brazil)**URL: <http://www.optex.net/br/es/sec/>**OPTEX (EUROPE) LTD. / EMEA HQ (U.K.)**URL: <http://www.optexeurope.com/>**OPTEX TECHNOLOGIES B.V.
(The Netherlands)**URL: <http://www.optex.eu/>**OPTEX SECURITY SAS (France)**URL: <http://www.optex-security.com/>**OPTEX SECURITY Sp.z o.o. (Poland)**URL: <http://www.optex.com.pl/>**OPTEX PINNACLE INDIA, PVT., LTD. (India)**URL: <http://www.optex.net/in/en/sec/>**OPTEX KOREA CO.,LTD. (Korea)**URL: <http://www.optexkorea.com/>**OPTEX (DONGGUAN) CO.,LTD.
SHANGHAI OFFICE (China)**URL: <http://www.optexchina.com/>



Hoch montierter
Außenmelder
HX-40/40AM/
40DAM

VERKABELTES MODELL



HX-40	2 PIRs Standardmodell
HX-40AM	HX-40 mit Anti-Masking
HX-40DAM	HX-40AM mit Mikrowellen

EIGENSCHAFTEN

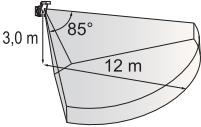

- 3,0 m Montagehöhe Erfassungsbereich (12 m)
- Einzigartiges Pyro-Element
- Intelligent UND logisch
- Duale Signalverarbeitungslogik
- Vegetationseinfluss-Analyselogik
- Ideale Einstellung des Erfassungsbereichs
- Digitales Anti-Masking (nur AM-/DAM-Modell)
- Mikrowellen-Reichweitenumschalter (nur DAM-Modell)
- ETL-zertifiziert für UL639 und ULC S306

INHALTSVERZEICHNIS

1] EINLEITUNG	2-5 WANDSABOTAGE (OPTION)..... 6
1-1 VOR DER INBETRIEBNAHME 1	3] GEHTEST 7
1-2 TEILEKENNZEICHNUNG 2	4] EINSTELLUNG
1-3 Erfassungsbereich..... 3	4-1 FUNKTION 8
2] INSTALLATION	5] BEREICH EINSTELLEN 10
2-1 MONTAGE MIT HALTERUNG 3	6] LED-ANZEIGE 10
2-2 VERTIKALEN WINKEL EINSTELLEN 5	7] SPEZIFIKATIONEN
2-3 MONTAGE OHNE HALTERUNG..... 5	7-1 SPEZIFIKATIONEN..... 11
2-4 VERKABELUNG 6	7-2 ABMESSUNGEN 11

1 EINLEITUNG

1-1 VOR DER INBETRIEBNAHME

Warnung	Die Nichteinhaltung der Anweisungen in diesem Handbuch und falsche Handhabung können zum Tod oder zu schweren Verletzungen führen.
Vorsicht	Die Nichteinhaltung der Anweisungen mit diesem Warnsymbol und falsche Handhabung können zu Verletzungen und/oder Sachschäden führen.

Die Markierung bedeutet Empfehlung. Das Nix-Symbol zeigt Unzulässigkeit an.

<p> Warnung</p> <p>Reparieren oder modifizieren Sie das Gerät nicht selbst</p>	<p> Warnung</p> <p>Schützen Sie das Gerät vor Wasser</p>	<p> Vorsicht</p> <p>Montieren Sie das Gerät sicher</p>
<p>Montagehöhe</p> <p>2,5 bis 3,0 m</p>	<p>Halten Sie den Melder parallel zum Boden.</p> <p>Parallel</p> <p>Neigung</p>	<p>Berücksichtigen Sie die Richtung, aus der sich eine Person nähert, sowie den Erkennungsbereich.</p>

Installieren Sie den Melder an einem Standort, der frei von Fehlalarmfaktoren ist. Beispielsweise:

• Sonneneinstrahlung und Reflektion

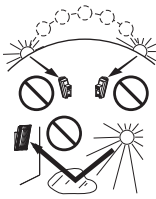

• Wärmequelle

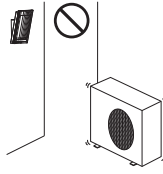

• Vom Wind bewegte Objekte

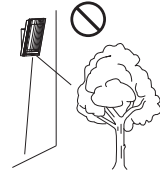

-Sicherheitshinweise zu Installation von zwei oder mehr Sensoren

HX-40
HX-40AM
HX-40DAM

Installieren Sie nicht zwei oder mehr HX-40DAM nebeneinander oder gegenüberliegend. Installieren Sie die Geräte Rückseite an Rückseite. Bei Montage auf der gleichen Wand achten Sie auf mindestens 1,0 m Abstand voneinander.

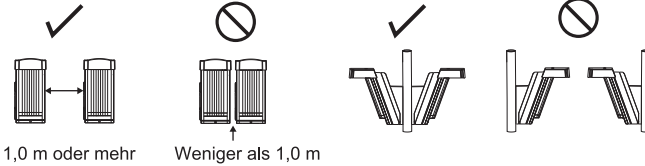

1-2 TEILEKENNZEICHNUNG

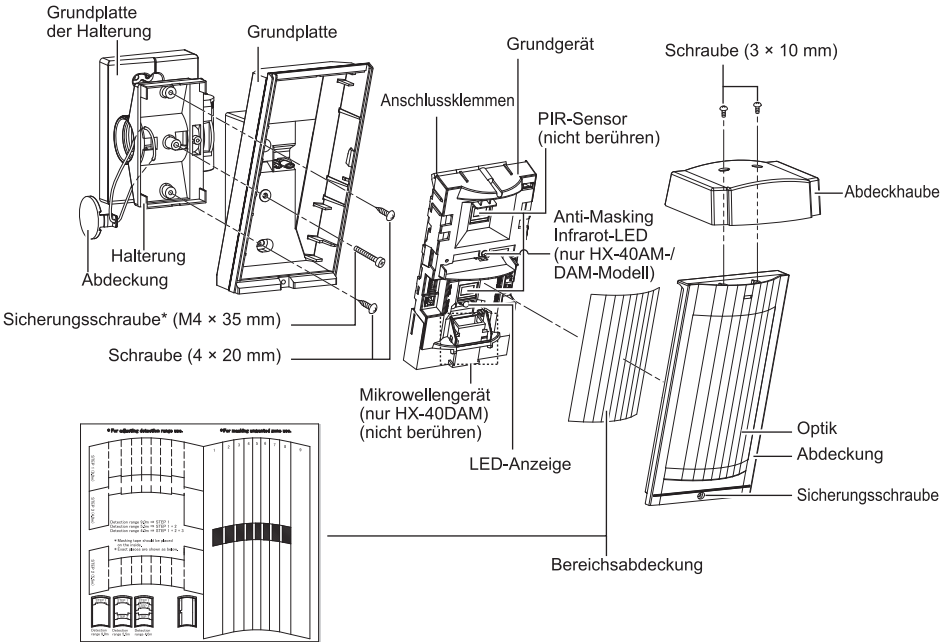

Schraubensatz		
Für Verbindung	Für Wandmontage	Für Abdeckung
Schraube (4 x 20 mm)	Schraube (4 x 20 mm)	Schraube (3 x 10 mm)

*Sicherungsschraube in Grundplatte der Halterung

Draufsicht

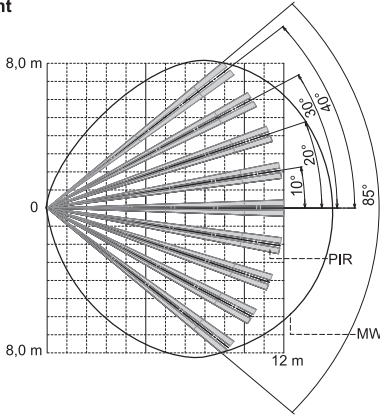

Seitenansicht

(Hauteur d'installation 3,0 m)

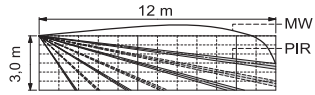

(Hauteur d'installation 2,5 m)

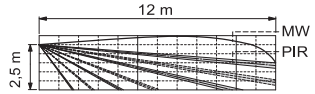

- Vertikaler Winkel: 1 Stufe (2,5°) hoch (siehe „Vorsicht“ in 2-2).

2 INSTALLATION

Verwenden Sie die Halterung für normale Montagen. Das Gerät kann nur ohne Halterung direkt auf der Wand installiert werden, wenn die folgenden drei Bedingungen gegeben sind:

- Montagehöhe 3,0 m.
- Keine horizontale Ausrichtung erforderlich;
- Der Boden ist eben.

2-1 MONTAGE MIT HALTERUNG

Mit der Halterung kann das Gerät horizontal um $\pm 90^\circ$ eingestellt werden.

Ist der Boden uneben und/oder nicht parallel zur Grundplatte des Geräts, so kann das Gerät vertikal um $\pm 20^\circ$ eingestellt werden.

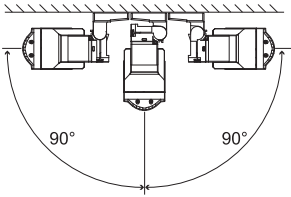

Vorsicht>>
Ändern Sie die Erfassungsbereichsweite nicht mit der Halterung. Verwenden Sie die Abdeckung zum Einstellen der Erfassungsbereichsweite.

- 1** Entfernen Sie die Sicherungsschraube für aufwärts/abwärts.

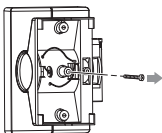

- 2** Schieben Sie die Schaftabdeckungsklammer nach außen Clip um die Schaftabdeckung zu entfernen.

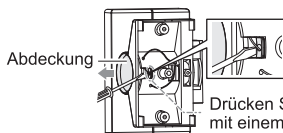

Drücken Sie mit einem geeigneten Werkzeug, z.B. kleiner Schraubendreher.

- 3** Lösen Sie die Einstellschraube zwei Umdrehungen.

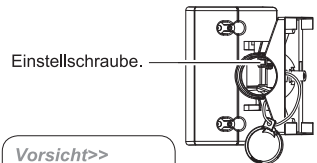

Vorsicht>>
Drehen Sie die Schraube nicht zu weit heraus.

- 4 Neigen Sie die Halterung ca. 45° und führen Sie das Kabel durch.

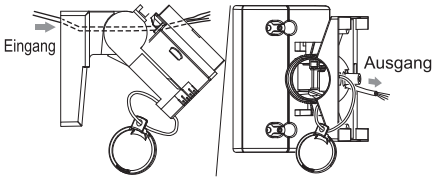

- 6 Öffnen Sie die Ausbrechöffnung für das Kabel.

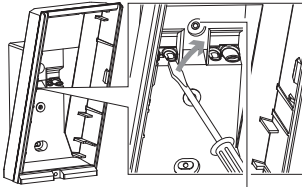

Verkabelung Ausbrechöffnung

- 8 Ziehen Sie die Schrauben ① und ② fest, stellen Sie den Winkel der Halterung ein (Siehe 2-2) und ziehen Sie dann die Schraube fest ③. Führen Sie eine Bereichsprüfung durch. Ist eine Korrektur erforderlich, so lösen Sie Schraube 3 und ändern Sie den Winkel der Halterung.

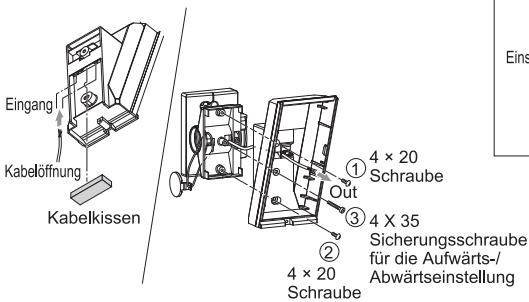

- 10 Schließen Sie das Kabel am Klemmblock an und installieren Sie Gerät und Optik auf der Grundplatte.

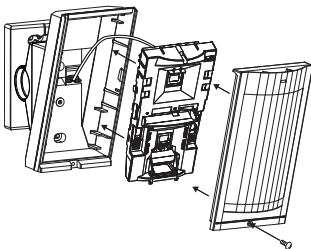

- 5 Bestimmen Sie die horizontale Ausrichtung (links oder rechts) des Melders, bevor Sie die Halterung auf der Wand montieren.

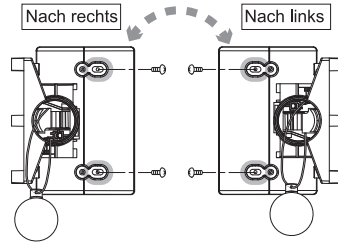

- 7 Öffnen Sie die Ausbrechöffnung für die Sicherungsschraube für die Aufwärts-/AbwärtsEinstellung zum Anschluss der Halterung.

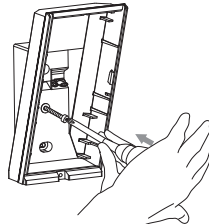

Ausbrechöffnung mit 4 × 20 Blechschraube (Schraubensatz)

- 9 Einstellschraube nach rechts anziehen.

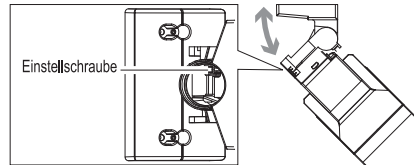

- 11 Rasten Sie die Schaftabdeckung ein.

2-2 VERTIKALEN WINKEL EINSTELLEN

Für beste Leistung installieren Sie den Melder parallel zum Boden.
Bestimmen Sie die Erfassungsreichweite. Wenn Sie 9,0 m/5,5 m/4,0 m wählen, maskieren Sie das unerwünschte Objektiv mit Abdeckungen.

Führen Sie den Gehstest durch um zu überprüfen, ob der Melder parallel zum Boden ist.

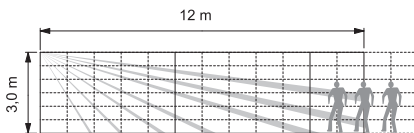

* Dies ist für eine Erfassungsreichweite von 12 m der Fall.

Wenn die Erfassungsreichweite kürzer als die festgelegte ist (Siehe Seite 3), ändern Sie den Melderwinkel aufwärts.

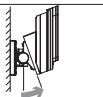

Wenn die Erfassungsreichweite länger als die festgelegte ist (Siehe Seite 3), ändern Sie den Melderwinkel abwärts.

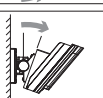

Wenn die Erfassungsreichweite gleich der festgelegten ist, sind die Anpassungen abgeschlossen.

Vorsicht>>

Für den Fall, dass die Grundplatte bereits parallel zum Boden ist,
• ändern Sie nicht die Länge des Erfassungsbereichs, indem Sie das Gerät aufwärts oder abwärts neigen.
Die Länge des Erfassungsbereichs muss mit der Abdeckung eingestellt werden. Einzelheiten siehe 2-1.

Beispiel (der Boden ist eben)

0° ist die richtige Einstellung für 3,0 m Montagehöhe.

Stellen Sie 1 Stufe (2,5° aufwärts) für 2,5 m Montagehöhe ein.

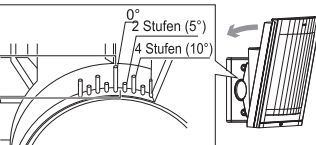

2-3 MONTAGE OHNE HALTERUNG

- 1 Öffnen Sie die Ausbrechöffnung mit einem geeigneten Werkzeug, z.B. Schraubendreher.

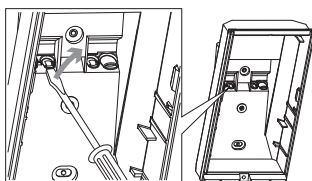

- 2 Ziehen Sie das Kabel durch die Ausbrechöffnung der Grundplatte.

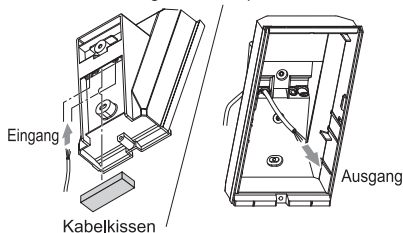

- 3 Befestigen Sie die Grundplatte an der Wand.

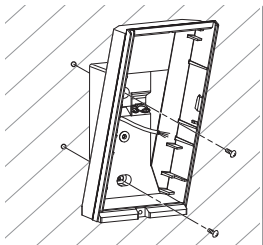

- 4 Anschließen und Gerät und Optik installieren.

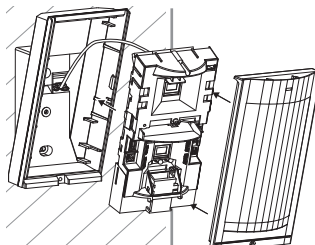

2-4 VERKABELUNG

Stromkabel dürfen die folgenden Längen nicht überschreiten.

Einheit: m

DRAHTQUERSCHNITT	HX-40		HX-40AM		HX-40DAM	
	12 V	14 V	12 V	14 V	12 V	14 V
AWG22 (0,33 mm ²)	160	360	140	310	120	250
AWG20 (0,52 mm ²)	260	560	230	490	180	390
AWG18 (0,83 mm ²)	410	900	360	780	290	630

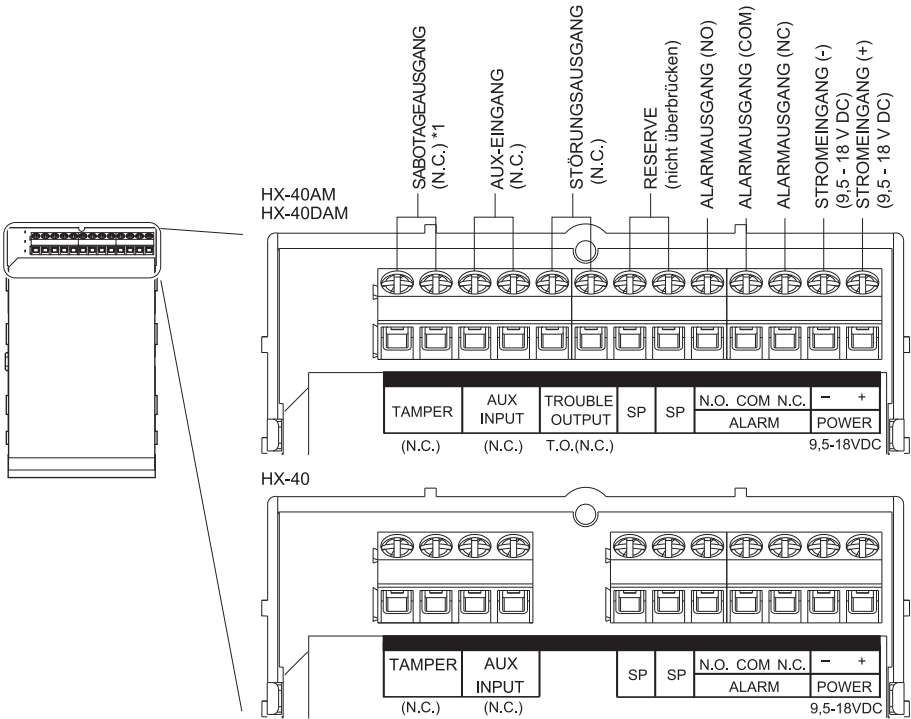

*1: SABOTAGE-Anschlüsse werden an Schleife 24 Stunden Überwachung angeschlossen.

2-5 WANDSABOTAGE (OPTION)

Der Universal-Magnetschalter kann als Wandsabotage montiert werden. Der Einbauplatz für den Universal-Magnetschalter befindet sich auf der Rückseite des Grundgeräts und der Halterung. Die maximale Größe eines geeigneten Universal-Magnetschalters: T 9 mm × B 40 mm × H 9 mm. Unterstützte Universal-Magnetschalter sind nicht im Lieferumfang enthalten.

Grundgerät



Magnetschalter (Wand) Position

Magnetschalter (Grundplatte) Position

Halterung

Kabelöffnung

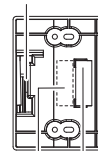

Magnetschalter (Wand) Position

Magnetschalter (Grundplatte) Position

-Installation

- 1 Installieren Sie den Universal-Magnetschalter (Wandseite) auf der Wand. Zur Bestimmung der Montageposition verwenden Sie die „Schablone zur Montageposition“ auf der Innenseite der Geräteabdeckung.

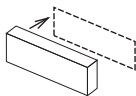

- 2 Öffnen Sie die Ausbrechöffnung mit einem geeigneten Werkzeug, z.B. Schraubendreher.

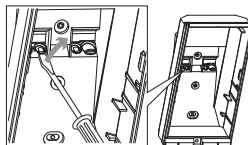

- 3 Montieren Sie den anderen Teil des Universal-Magnetschalters auf der Rückseite des Geräts oder der Halterung. Kabel durch die Ausbrechöffnungen ziehen.

Ohne Halterung

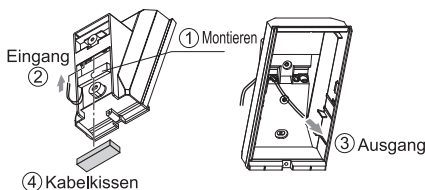

Mit Halterung

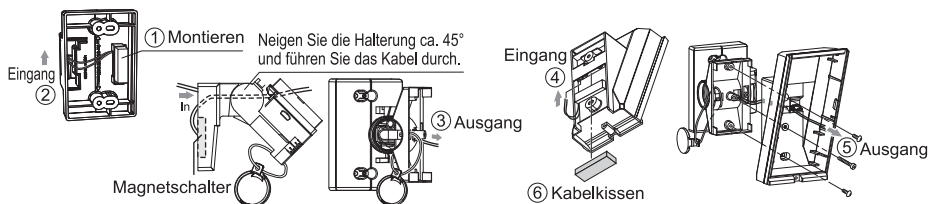

- 4 Installieren Sie Halterung und Gerät auf der Wand.

- 5 Schließen Sie den Magnetschalter am Sabotageanschluss des Geräts an.

3 GEHTEST

- 1 Stellen Sie DIP-Schalter 1 (LED EIN/AUS) auf „ON“.

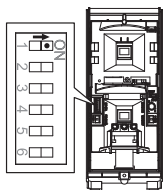

- 2 Vergewissern Sie sich, dass der Melder ein Objekt im vorgesehenen Erfassungsbereich erkennt. Die Installation war erfolgreich, wenn die LED für zwei Sekunden leuchtet, nachdem eine Person in den Erfassungsbereich läuft.

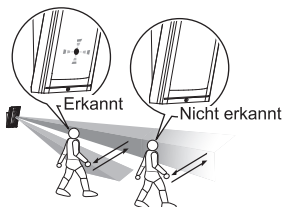

- 3 Ist eine ständige LED-Anzeige nicht gefordert, so stellen Sie DIP-Schalter 1 (LED EIN/AUS) auf „OFF“.

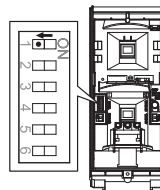

Hinweis>>

Der Schalter ist werksseitig auf „ON“ eingestellt.

Hinweis>>

- Bewegen Sie sich für den Gehstest mehr als 1,0 m vom Melder weg.
- Führen Sie mindestens einmal im Jahr eine Funktionsprüfung durch.

4 EINSTELLUNG

4-1 FUNKTION

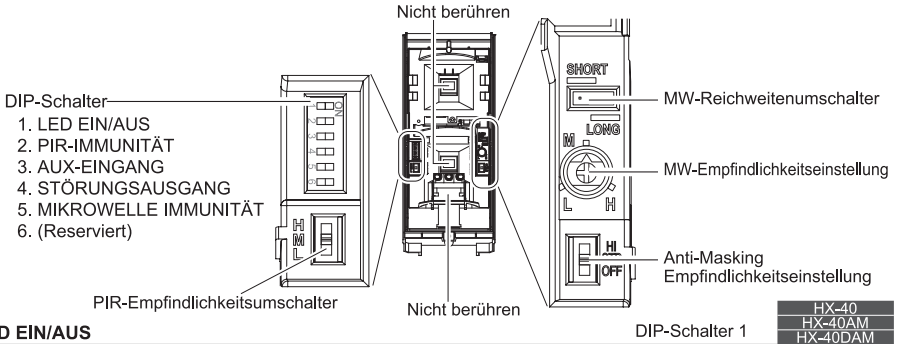

HX-40
HX-40AM
HX-40DAM

-LED EIN/AUS



POSITION	FUNKTION
EIN (Werkseinstellung)	Die LED leuchtet auf, wenn eine Person erkannt wird.
AUS	Die LED leuchtet nicht auf, selbst wenn eine Person erkannt wird.

-PIR-IMMUNITÄT



DIP-Schalter 2

HX-40
HX-40AM
HX-40DAM

POSITION	FUNKTION
STD (Werkseinstellung)	PIR-IMMUNITÄT Logik ist nicht aktiviert.
IMMUNITÄT	PIR-IMMUNITÄT Logik ist aktiviert. Unter harschen Umweltbedingungen verwenden (z.B. kleine Tiere).

-AUX-EINGANG

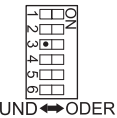

DIP switch 3

HX-40
HX-40AM
HX-40DAM

Durch Anschluss einer Satelliteneinheit (eine weitere Warnsensor) können Sie den Erfassungsbereich erweitern und Fehlalarme korrigieren. Als Satelliteneinheit können Sie jeden allgemeinen spannungslosen Ausgangskontakt (NC) Warnsensor verwenden, einschließlich folgender: <Infrarotsensoren (AIR), Wärmesensoren (PIR), Universal-Magnetschalter usw.>

POSITION	FUNKTION
UND (Werkseinstellung)	Wenn sowohl das Grundgerät als auch der Satellit jemanden entdecken, wird ein Alarm ausgegeben. Stellen Sie dies ein, wenn Sie kein Satellitengerät angeschlossen haben.
ODER	Wenn sowohl das Grundgerät als auch der Satellit jemanden entdecken, wird ein Alarm ausgegeben.

NHinweise>>

- Der Alarm wird nicht ausgegeben, bis sowohl das Grundgerät als auch der Satellit innerhalb von 60 Sekunden jemanden entdeckt haben.
- Wenn der ODER-Modus ohne ein angeschlossenes Satellitengerät ausgewählt wurde, wird der Alarm kontinuierlich ausgelöst.

-STÖRUNGSAUSGANG

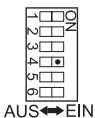

DIP-Schalter 4

HX-40
HX-40AM
HX-40DAM

Der Störungsausgang wird für das Anti-Masking-Signal verwendet. Befindet sich ein Objekt länger als 180 Sekunden dicht vor der Optik, so wird der IR Anti-Masking-Schaltkreis aktiviert und generiert ein Störungssignal.

POSITION	FUNKTION
EIN (Werkseinstellung)	Anti-Masking Signal wird vom Störungsausgang ausgegeben.
AUS	Ausgabe vom Störungs- und Alarmausgang.

NHinweise>>

Verwenden Sie diese Option, wenn auf dem Bedienfeld keine Eingangsklemme für eine erkannte Störung verkabelt wurde.

-MIKROWELLE IMMUNITÄT

DIP-Schalter 5

HX-40
HX-40AM
HX-40DAM



STD ↔ IMMUNITÄT

POSITION	FUNKTION
STD (Werkseinstellung)	MIKROWELLENIMMUNITÄT-Logik ist nicht aktiviert.
IMMUNITÄT	MIKROWELLENIMMUNITÄT-Logik ist aktiviert. Unter harschen Umweltbedingungen verwenden (z.B. Vegetationseinfluss).

REICHWEITENUMSCHALTER/
EMPFINDLICHKEIT
EINSTELLEN

HX-40
HX-40AM
HX-40DAM

-MW-REICHWEITENUMSCHALTER/MW-EMPFINDLICHKEIT E INSTELLEN

PIR-BEREICH EINSTELLEN	ERFASSUNGSBEREICH (SEITENANSICHT)	MW-REICHWEITENUMSCHALTER	MW-EMPFINDLICHKEITSEINSTELLUNG
12 m Werkseinstellungen		WEIT 	MITTEL
9,0 m 		KURZ 	HOCH
5,5 m 		KURZ 	MITTEL
4,0 m 		KURZ 	NIEDRIG

-PIR-EMPFINDLICHKEIT

PIR EMPFINDLICHKEITS-UMSCHALTER

HX-40
HX-40AM
HX-40DAM

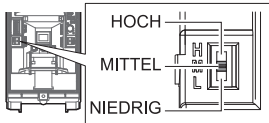

POSITION	FUNKTION
HOCH	Hohe Empfindlichkeit
MITTEL (Werkseinstellung)	Mittlere Empfindlichkeit
NIEDRIG	Geringe Empfindlichkeit

-ANTI-MASKING EMPFINDLICHKEIT

ANTI-MASKING EMPFINDLICHKEITS-UMSCHALTER

HX-40
HX-40AM
HX-40DAM

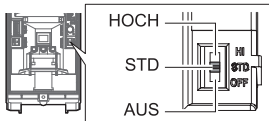

POSITION	FUNCTION
HOCH	Hohe Empfindlichkeit
STD (Werkseinstellung)	Standard Empfindlichkeit
AUS	Deaktiviert

Vorsicht>>

Lassen Sie beim Schließen der Abdeckung kein Objekt innerhalb eines Abstands 1,0 m zum Gerät.

ENGLISH

FRANÇAIS

DEUTSCH

ITALIANO

ESPAÑOL

PORTUGUÊS

5 BEREICH EINSTELLEN

-Länge des Erfassungsbereichs einstellen

Zur Begrenzung der Erkennungsreichweite verwenden Sie die entsprechende Abdeckung. Bitte beachten Sie, dass drei verschiedene Abdeckungen vorhanden sind.

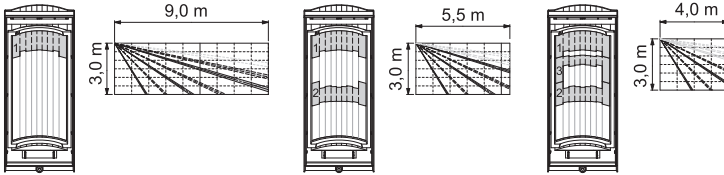

-BEREICHSABDECKUNG

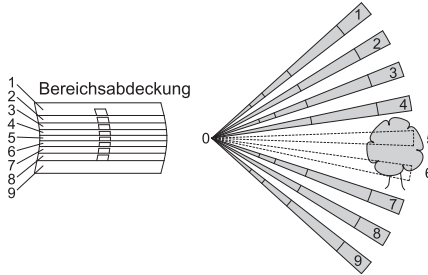

Beispiel Abdeckung Bereiche 5 und 6.

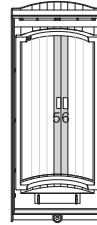

6 LED-ANZEIGE

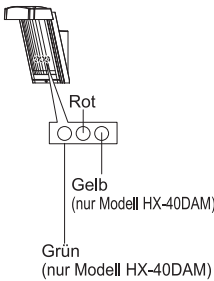

Blinkt
 Leuchtet
 AUS

-HX-40/40AM

ZUSTAND MELDER		LED-ANZEIGE (NUR ROT)
Aufwärmen		 Blinkt für ca. 60 Sekunden
Alarm		 Leuchtet für 2 Sekunden
Störungsausgang	Anti-Masking-Start (Anti-Masking Start)	 Blinkt 2 Mal, aus für 5 Sekunden und dann Wiederholung für 180 Sekunden
	Erkennen der Abdeckung	 Blinkt 3 Mal, aus für 3 Sekunden und Wiederholung

-HX-40DAM

ZUSTAND MELDER		LED-ANZEIGE
Aufwärmen		 Blinkt für ca. 60 Sekunden
Alarm		 Rot leuchtet für 2 Sekunden
PIR-Erkennung		 Grün leuchtet für 2 Sekunden
MW-Erkennung		 Gelb leuchtet für 2 Sekunden
Störungsausgang	Anti-Masking-Start (Anti-Masking Start)	 Grün und Rot blinken 2 Mal, aus für 5 Sekunden und Wiederholung für 180 Sekunden
	Erkennen der Abdeckung	 Grün und Rot blinken 3 Mal, aus für 3 Sekunden und Wiederholung.

7 TECHNISCHE DATEN

7-1 TECHNISCHE DATEN

Modell	HX-40	HX-40AM	HX-40DAM
Erkennungsverfahren	Passiv Infrarot		Passiv Infrarot und Mikrowelle
PIR-Abdeckung	12 m 85° breit/94 Zonen		
PIR-Abstandsgrenze	4,0 m, 5,5 m, 9,0 m		
Erkennbare Geschwindigkeit	0,3 m/s bis 1,5 m/s		
Empfindlichkeit	2,0°C bei 0,6 m/s		
Stromeingang	9,5 bis 18 VDC		
Stromaufnahme	35 mA (max.) bei 12 VDC	40 mA (max.) bei 12 VDC	50 mA (max.) bei 12 VDC
Alarmdauer	2,0 ±1 sec.		
Aufwärmzeitraum	Ca. 60 s (LED blinkt)		
Alarmausgang	Form C 28 VDC 0,2 A (max.)		
Sabotageausgang	Ruhekontakt 28 VDC, 0,1 A (max.) Ruhekontakt offen, wenn Gehäuse entfernt.		
Störungsausgang	-		
Aux-Eingang	Ruhekontakt 28 VDC, 0,1 A (max.)		
LED-Anzeige	Rot: Aufwärmen, Alarm	Rot: Aufwärmen, Alarm, Störung	Rot: Warm-up, Alarm, Störung Grün: Aufwärmen, PIR-Erkennung, Störung Gelb: Aufwärmen, MW-Erkennung
Betriebstemperatur	-20 bis +60 °C		
Luftfeuchtigkeit	95% (max.)		
Wetterschutz	IP55		
Montage	Wand		
Montagehöhe	2,5 bis 3,0 m		
Halterung Einstellwinkel	Vertikal: ±20° Horizontal: ±95°		
Gewicht	600 g		700 g
Zubehör	Halterung, Abdeckhaube, Bereichsabdeckung seal, Schraube (3 x 10 mm) x 2, Schraube (4 x 20 mm) x 4		

* Änderung der technischen Daten und des Designs vorbehalten.

7-2 ABMESSUNGEN

Mit Halterung und Abdeckhaube

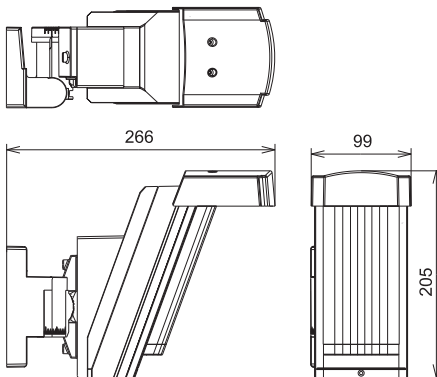

Einheit: mm

Ohne Halterung und Abdeckhaube

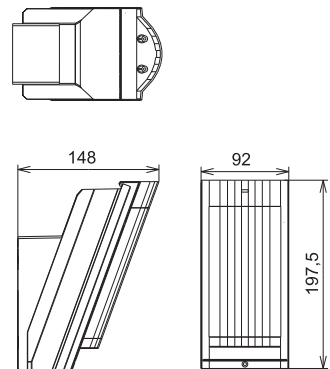

Einheit: mm

ENGLISH

FRANÇAIS

DEUTSCH

ITALIANO

ESPAÑOL

PORTUGUÊS

**OPTEX INC. (U.S.)**URL: <http://www.optexamerica.com/>**OPTEX DO BRASIL LTDA. (Brazil)**URL: <http://www.optex.net/br/es/sec/>**OPTEX (EUROPE) LTD. / EMEA HQ (U.K.)**URL: <http://www.optexeurope.com/>**OPTEX CO., LTD. (JAPAN)**URL: <http://www.optex.net/>**OPTEX TECHNOLOGIES B.V.
(The Netherlands)**URL: <http://www.optex.eu/>**OPTEX SECURITY SAS (France)**URL: <http://www.optex-security.com/>**OPTEX SECURITY Sp.z o.o. (Poland)**URL: <http://www.optex.com.pl/>**OPTEX PINNACLE INDIA, PVT., LTD. (India)**URL: <http://www.optex.net/in/en/sec/>**OPTEX KOREA CO.,LTD. (Korea)**URL: <http://www.optexkorea.com/>**OPTEX (DONGGUAN) CO.,LTD.
SHANGHAI OFFICE (China)**URL: <http://www.optexchina.com/>



Rilevatore per esterni
a fissaggio alto
**HX-40/40AM/
40DAM**

MODELLO CABLATO

HX-40	Modello standard con doppio PIR
HX-40AM	Modello HX-40 con anti-mascheramento
HX-40DAM	Modello HX-40AM a micro-onde

CARATTERISTICHE

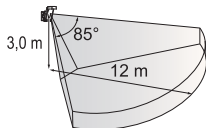

- Area di rilevamento (12 m) con altezza di montaggio a 3,0 m
- Piroelemento esclusivo
- Intelligente E logico
- Doppia logica di elaborazione dei segnali
- Logica per l'analisi delle oscillazioni della vegetazione
- Impostazione dell'area di rilevamento ideale
- Sistema anti-mascheramento digitale (solo sui modelli AM/DAM)
- Selettore intervallo micro-onde (solo sui modelli DAM)
- Certificazione ETL per UL639 e ULC S306

INDICE

1 INTRODUZIONE	2-5 DISPOSITIVO ANTI-MANOMISSIONE A MURO (OPZIONALE)..... 6
1-1 PRIMA DELL'USO	1
1-2 DESCRIZIONE DELLE PARTI.....	2
1-3 AREA DI RILEVAMENTO	3
2 INSTALLAZIONE	3 TEST DI TRANSITO..... 7
2-1 MONTAGGIO CON SQUADRETTA.....	3
2-2 REGOLAZIONE DELL'ANGOLO VERTICALE	5
2-3 MONTAGGIO SENZA SQUADRETTA.....	5
2-4 COLLEGAMENTI	6
	4 IMPOSTAZIONI
	4-1 FUNZIONE
	5 IMPOSTAZIONE AREA DI RILEVAMENTO
	6 INDICATORI LED.....
	7 CARATTERISTICHE TECNICHE
	7-1 CARATTERISTICHE TECNICHE.....
	7-2 DIMENSIONI

1 INTRODUZIONE

1-1 PRIMA DELL'USO

	Pericolo La mancata osservanza delle istruzioni fornite in corrispondenza di questa indicazione e l'uso improprio possono causare la morte o lesioni gravi.
	Avvertenza La mancata osservanza delle istruzioni fornite in corrispondenza di questa indicazione e l'uso improprio possono causare lesioni e/o danni materiali.

Il segno di spunta ✓ indica una raccomandazione. Il simbolo di divieto indica un divieto.

<p> Pericolo</p> <p>Non riparare o modificare l'apparecchio</p>	<p> Pericolo</p> <p>Non versare acqua sull'apparecchio</p>	<p> Avvertenza</p> <p>Fissare in modo sicuro</p>
<p>Altezza di montaggio</p> <p>Da 2,5 a 3,0 m</p>	<p>Tenere il rilevatore parallelo al suolo.</p> <p>Parallelo Inclinato</p>	<p>Si consideri la direzione di una persona che si avvicina e l'area di rilevamento.</p>

Installare il rilevatore in un luogo in cui non siano presenti possibili cause di falso allarme. Ad esempio:

• Luce del sole e riflessi



• Fonte di calore

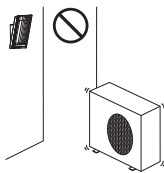

• Oggetti mossi dal vento

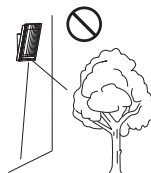

-Precauzioni in caso di installazione di due o più sensori

HX-40
HX-40AM
HX-40DAM

Non installare due o più unità del modello HX-40DAM l'una a fianco all'altra o di fronte. Installarle sempre in modo che il retro delle unità sia esposto. Se si montano le unità sulla stessa parete, assicurarsi che esse distino almeno 1,0 m l'una dalle altre.

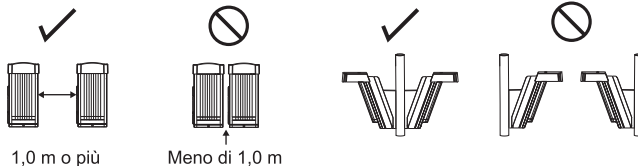



1,0 m o più

Meno di 1,0 m

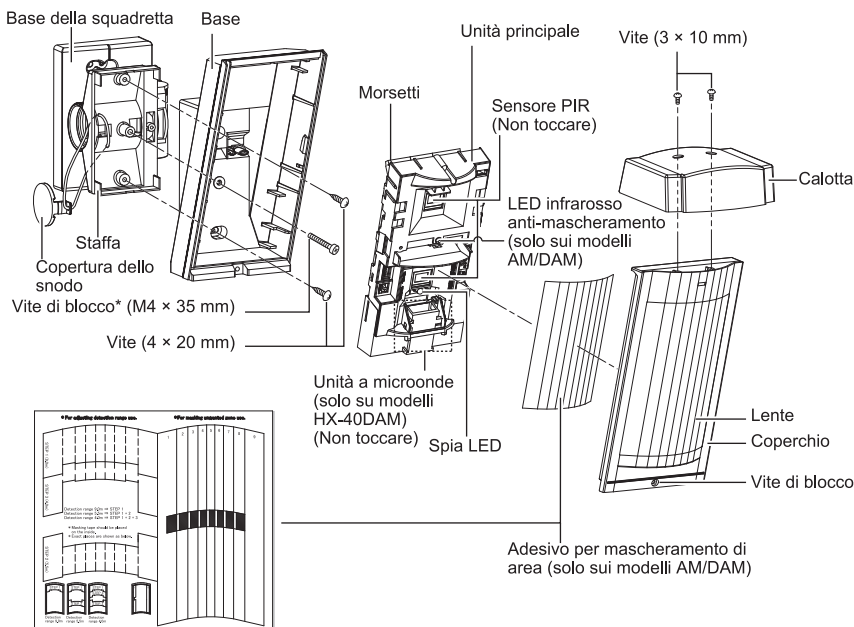
1-2 DESCRIZIONE DELLE PARTI



Kit di viti

Per l'assemblaggio	Per il montaggio a parete	Per calotta
Vite (4 × 20 mm)	Vite (4 × 20 mm)	Vite (3 × 10 mm)
		

*Vite di blocco applicata sulla base della squadretta

Vista dall'alto

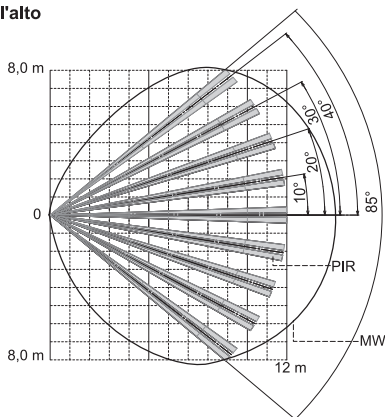

Vista laterale

(Altezza di montaggio: 3,0 m)

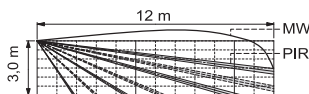

(Altezza di montaggio: 2,5 m)

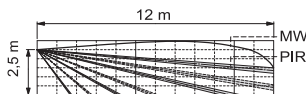

- Angolo verticale: 1 scatto (2,5°) verso l'alto (Fare riferimento alla voce "precauzione" nella sezione 2-2).

2 INSTALLAZIONE

Usare la squadretta per la normale installazione. L'unità può essere montata direttamente al muro, senza staffe, solo se le tre seguenti condizioni siano presenti;

- L'altezza di montaggio è di 3 m.
- Non sono necessari aggiustamenti in direzione orizzontale
- Il terreno è in piano.

2-1 MONTAGGIO CON SQUADRETTA

L'uso della squadretta consente di applicare all'unità una regolazione orizzontale di $\pm 90^\circ$.

Nei casi dove il terreno è irregolare e quindi non perpendicolare alla base del rivelatore, è possibile regolare l'inclinazione dell'apparecchio in modo verticale di $\pm 20^\circ$.

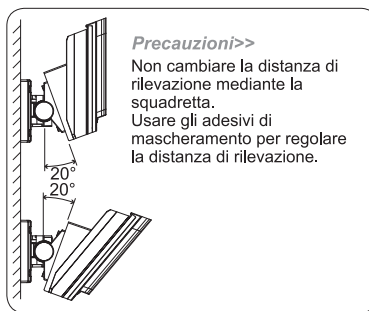
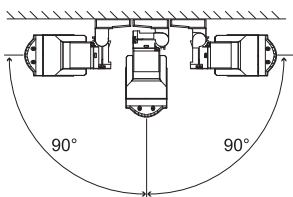

- 1 Togliere la vite di 2 3 bloccaggio su/giù.

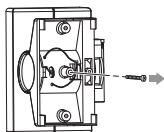

- 2 Spingere verso l'esterno la molletta del coperchio dello snodo per rimuoverlo.

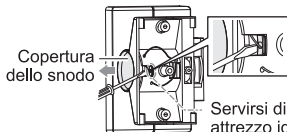

- 3 Allentare la vite di regolazione per due giri.

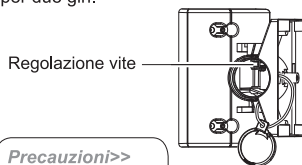

Precauzioni>>
Non allentare troppo la vite o la vite si epara dall'apparecchio.

- 4 Inclinare la squadretta di circa 45° e far passare i cavi.

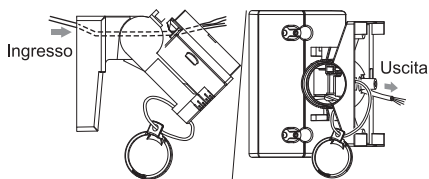

- 6 Aprire il foro di uscita del passaggio cavi.

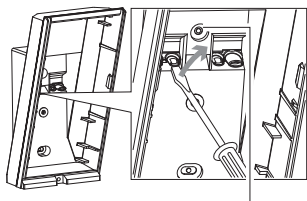

Foro di uscita del passaggio cavi.

- 8 Serrare le viti ① e ②, regolare l'angolo della squadretta (fare riferimento a 2-2), quindi serrare la vite ③.

Controllare l'area. Se è necessario applicare aggiustamenti ulteriori, allentare la vite 3 e modificare come richiesto l'angolo della squadretta. Dopo aver applicato la modifica, stringere di nuovo la vite 3.

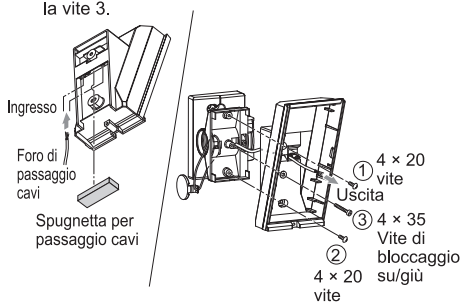

- 10 Effettuare i collegamenti alla morsetteria e fissare l'unità principale e la lente sulla base.

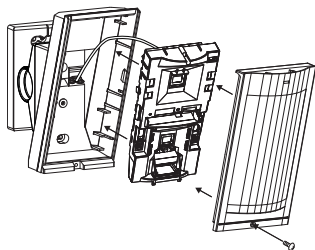

- 5 Fissare la direzione orizzontale (verso sinistra o destra) del rilevatore, prima di installare la squadretta alla parete.

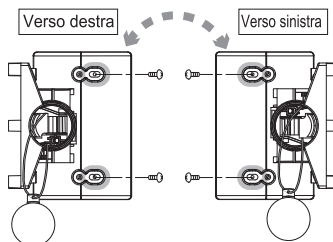

- 7 Aprire il foro a sfondare del passaggio cavi e quello della vite di bloccaggio su/giù per la squadretta.

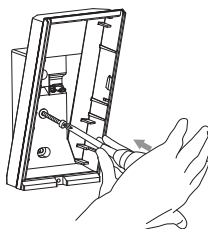

Servirsi delle viti a filettatura 4 x 20 (dal kit viti)

- 9 Serrare la vite di regolazione in senso orario.

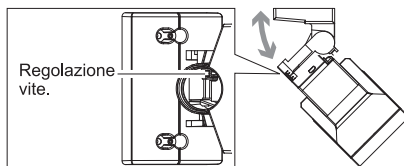

- 11 Installare la copertura dello snodo in posizione.

2-2 REGOLAZIONE DELL'ANGOLO VERTICALE

Per poter avere la giusta prestazione, impostare l'angolo verticale perpendicolare al terreno. Stabilire prima di tutto la distanza di rilevazione desiderata. Se scegliete m 9,0 / m 5,5 / m 4,0, mascherare la lente indesiderata con gli adesivi di mascheramento.

Eeguire un test di deambulazione per verificare se il rilevatore è installato parallelamente al terreno.

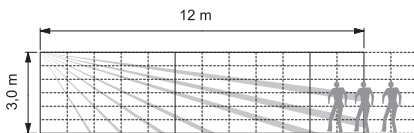

* Questo è il caso per avere una distanza di rilevazione di 12 metri.

Se la distanza di rilevamento dovesse risultare minore di quella impostata (fare riferimento a pagina 3), modificare l'inclinazione del rilevatore verso l'alto.

Se la distanza di rilevamento dovesse risultare maggiore di quella impostata (fare riferimento a pagina 3), modificare l'inclinazione del rilevatore verso il basso.

Se notate la rilevazione alla distanza prestabilita, non occorre fare alcuna regolazione.

Precauzione>>

In caso la base dell'unità sia già parallela al terreno.
Non modificare la distanza di rilevamento, inclinando in alto o in basso dell'unità.
La distanza di rilevamento deve essere impostata servendosi degli adesivi di mascheramento. Fare riferimento alle sezioni 2-1 per ulteriori dettagli.

Esempio (il terreno è in piano)

0° è la giusta impostazione per un'installazione a 3,0 m di altezza.

Regolare di 1 scatto (2,5° verso l'alto) per un'installazione a 2,5 m di altezza.

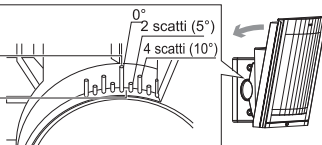

2-3 MONTAGGIO SENZA SQUADRETTA

- 1 Aprire il foro a sfondare per passaggio cavi con un attrezzo idoneo, ad esempio un cacciavite.

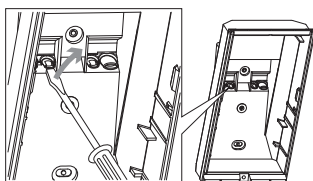

- 2 Far scorrere i cavi attraverso il foro di apertura della base.

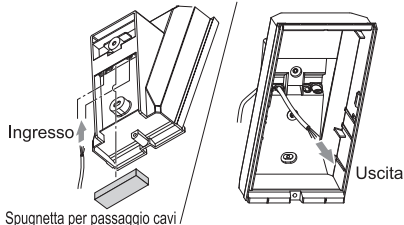

- 3 Fissare la base alla parete

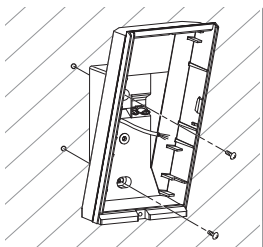

- 4 Installare l'unità principale dopo il cablaggio del terminale.

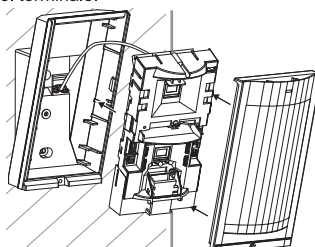

2-4 COLLEGAMENTI

I cavi di alimentazione non dovrebbero superare le seguenti lunghezze.

Unità di misura: m

CAVO	HX-40		HX-40AM		HX-40DAM	
	12 V	14 V	12 V	14 V	12 V	14 V
AWG22 (0,33 mm ²)	160	360	140	310	120	250
AWG20 (0,52 mm ²)	260	560	230	490	180	390
AWG18 (0,83 mm ²)	410	900	360	780	290	630

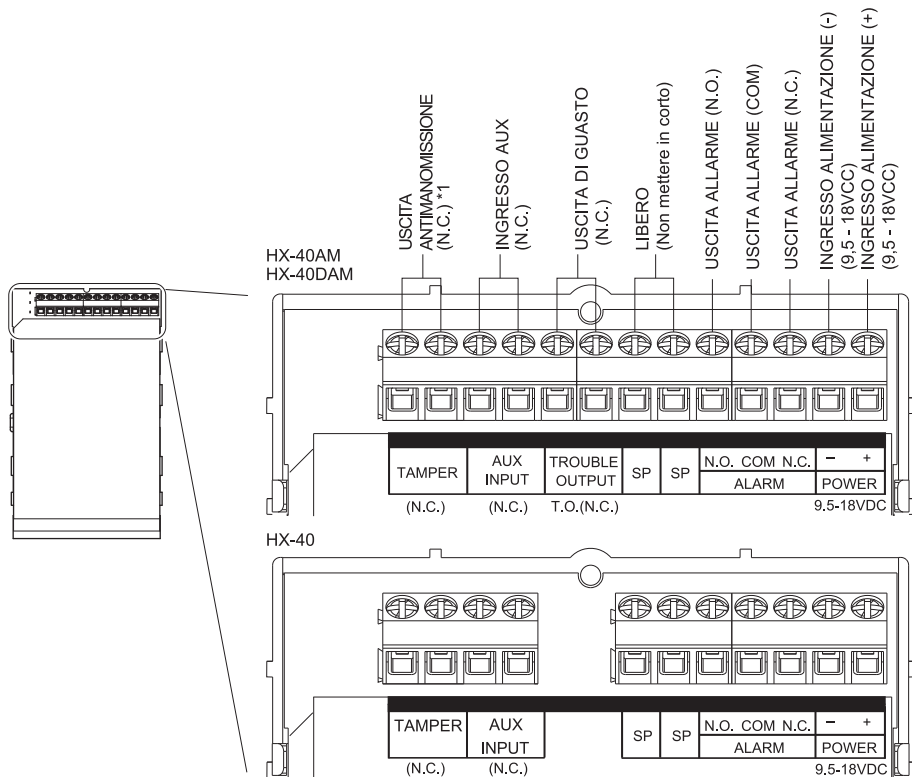

*1: I morsetti MANOMISSIONE vanno collegati al circuito supervisionato 24-ore.

2-5 DISPOSITIVO ANTI-MANOMISSIONE A MURO (OPZIONALE)

Un interruttore magnetico di tipo universale può essere applicato come dispositivo anti-manomissione a muro.

Lo spazio di installazione per l'interruttore magnetico universale è fornito sul retro dell'unità principale e della squadretta.

Dimensione max di un interruttore magnetico universale applicabile: D 9 x W 40 x H 9 mm

Interruttore magnetico universale non incluso.

Unità principale

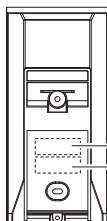

posizione interruttore magnetico (lato parete)

posizione interruttore magnetico (lato base)

Staffa

Foro di passaggio cavi

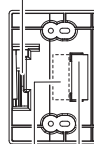

posizione interruttore magnetico (lato base)
posizione interruttore magnetico (lato parete)

-Installazione

- 1 Installare l'interruttore magnetico universale (lato muro) sul muro. Per determinare la posizione di installazione, utilizzare lo "schema di installazione" riportato nella copertina interna della confezione.
- 2 Aprire il foro di passaggio dei cavi con un attrezzo idoneo, ad es. con un cacciavite.

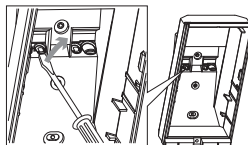
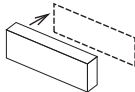

- 3 Installare l'altra parte dell'interruttore magnetico sul retro dell'unità principale o della squadretta. Tirare i cavi attraverso i passacavi.

Senza squadretta in uso

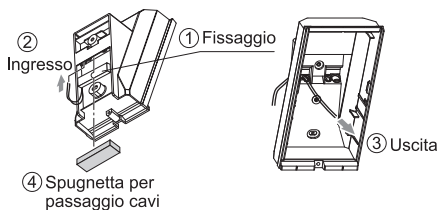

Con squadretta in uso

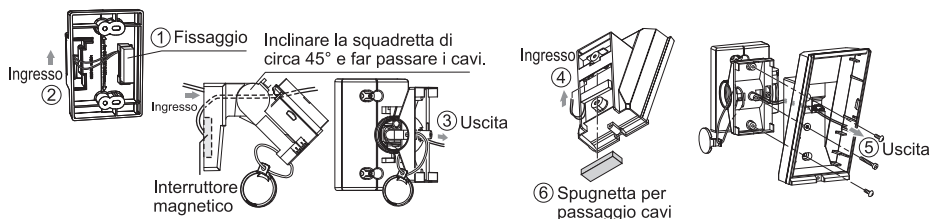

- 4 Applicare la squadretta e l'unità principale alla 5 superficie della parete.
- 5 Collegare i cavi dell'interruttore ai morsetti anti-manomissione dell'unità principale.

3 TEST DI TRANSITO

- 1 Impostare l'interruttore DIP 1 (LED ACCESO/ SPENTO) su "ON".
- 2 Verificare che il rilevatore sia in grado di individuare oggetti nell'area di rilevamento definita. In caso di installazione riuscita, l'indicatore LED si accende per due secondi, se una persona transita nell'area sorvegliata.
- 3 Se l'accensione del LED non è richiesta sempre, impostare l'interruttore DIP 1 (LED ON/OFF) a "OFF".

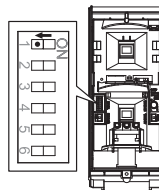
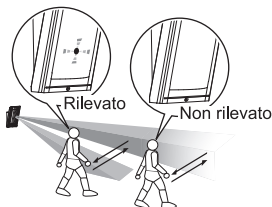
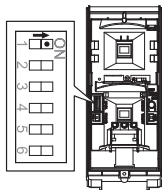

Nota>>

L'interruttore è impostato su "ON" per impostazione predefinita.

Nota>>

- Per il test di transito, allontanarsi di oltre 1,0 m dal rilevatore.
- Eseguire un test di transito almeno una volta all'anno.

4 IMPOSTAZIONI

4-1 FUNZIONE

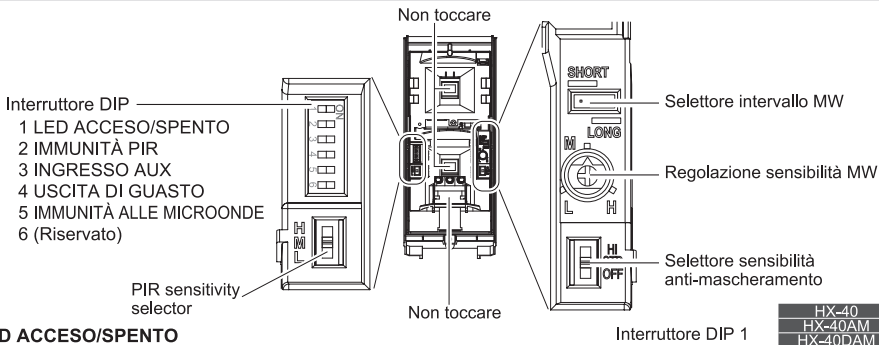

-LED ACCESO/SPENTO

Interruttore DIP 1

HX-40
HX-40AM
HX-40DAM



SPENTO ↔ ACCESO

POSIZIONE	FUNZIONE
ACCESO (impostazione predefinita)	Il LED si accende quando viene rilevato un movimento.
SPENTO	Il LED non si accende quando viene rilevato un movimento.

-MMUNITÀ PIR

Interruttore DIP 2

HX-40
HX-40AM
HX-40DAM



STD ↔ IMMUNITÀ

POSIZIONE	FUNZIONE
STD (impostazione predefinita)	La logica di IMMUNITÀ PIR non è attiva.
IMMUNITÀ	La logica di IMMUNITÀ PIR è attiva. Impostare quando il rivelatore è installato in luoghi con piccoli animali o condizioni avverse.

-INGRESSO AUX

Interruttore DIP 3

HX-40
HX-40AM
HX-40DAM

Collegando un rivelatore supplementare (un altro rivelatore di movimento), è possibile estendere l'area di rilevazione e correggere falsi allarmi. Come rivelatore supplementare è possibile usare ogni rivelatore di uso generale con uscita di contatto N.C. non alimentato, comprese barriere a raggi infrarossi, rivelatori PIR di movimento, contatti magnetici, ecc.

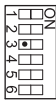

E ↔ OR

POSIZIONE	FUNZIONE
E (impostazione predefinita)	Quando entrambi i rivelatori, l'unità principale e quello supplementare rilevano un movimento, viene attivata l'uscita di allarme. Impostare così quando non è collegata un'unità supplementare.
O	Quando il rivelatore principale o quello supplementare rilevano un movimento, l'allarme viene rilasciato.

Nota >>

- L'allarme non viene rilasciato a meno che entrambi i rivelatori, l'unità principale e quella supplementare rilevano un movimento entro 60 secondi.
- Se si seleziona la modalità O senza un'unità satellite connessa, l'allarme è emesso ininterrottamente.

-USCITA GUASTO

Interruttore DIP 4

HX-40
HX-40AM
HX-40DAM

L'uscita guasto viene usata per il segnale anti-mascheramento. Quando viene piazzato un oggetto vicino alla superficie della lente, per un periodo maggiore di 180 secondi, il circuito anti-mascheramento ad infrarossi attiva e rilascia un segnale di guasto.



SPENTO ↔ ACCESO

POSIZIONE	FUNZIONE
ACCESO (impostazione predefinita)	L' uscita guasto viene usata per produrre il segnale anti-mascheramento.
SPENTO	Il segnale proviene sia dall'uscita Guasto che da quella Allarme.

Nota >>

Usare quando non si collega un ingresso dedicato di guasto sulla centrale d'allarme

-IMMUNITÀ MICROONDE

Interruttore DIP 5

HX-40
HX-40AM
HX-40DAM

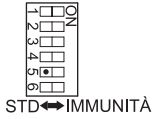

POSIZIONE	FUNZIONE
STD (impostazione predefinita)	La logica IMMUNITÀ ALLE MICROONDE non è attivata.
IMMUNITÀ	La logica IMMUNITÀ ALLE MICROONDE è attivata. Utilizzare questo in ambienti difficile (es. ondeggiamento della vegetazione).

-REGOLAZIONE SELETTORE INTERVALLO MW/SENSIBILITÀ MW

REGOLAZIONE SELETTORE
INTERVALLO/SENSIBILITÀ
IMPOSTAZIONE AREA PIR

HX-40
HX-40AM
HX-40DAM

IMPOSTAZIONE AREA PIR	AREA DI RILEVAMENTO (VISIONE LATERALE)	SELETTORE INTERVALLO MW	REGOLAZIONE SENSIBILITÀ MW
12 m Impostazione predefinita		LUNGO BREVE	MEDIO
9,0 m		BREVE LUNGO	ELEVATA
5,5 m		BREVE LUNGO	MEDIO
4,0 m		BREVE LUNGO	BASSA

-SENSIBILITÀ PIR

Selettore sensibilità PIR

HX-40
HX-40AM
HX-40DAM

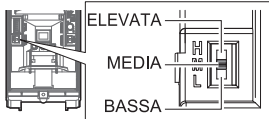

POSIZIONE	FUNZIONE
ELEVATA	Alta sensibilità
MEDIA (impostazione predefinita)	Media sensibilità
BASSA	Bassa sensibilità

-SENSIBILITÀ ANTI-MASCHERAMENTO

Selettore sensibilità antimascheramento

HX-40
HX-40AM
HX-40DAM

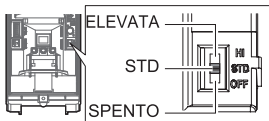

POSIZIONE	FUNZIONE
ELEVATA	Alta sensibilità
STD (impostazione predefinita)	Sensibilità Standard
SPENTO	Disattivato

Precauzione>>>

Alla chiusura della copertura, non lasciare alcun oggetto nel raggio di 1,0 m dall'unità.

5 IMPOSTAZIONE AREA DI RILEVAMENTO

-Regolazione distanza di rilevamento

Per limitare la lunghezza di rilevamento, applicare l'adesivo di mascheramento appropriato. Si noti che sono disponibili tre diversi tipi di adesivo.

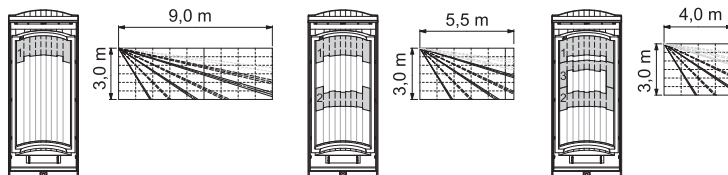

-MASCHERAMENTO AREE

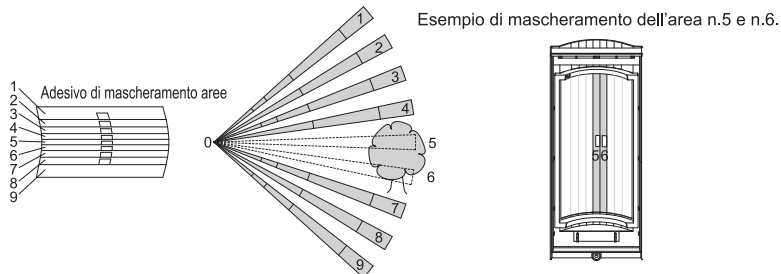

Esempio di mascheramento dell'area n.5 e n.6.

6 INDICATORI LED

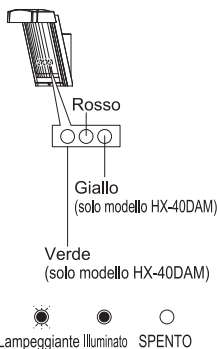

-HX-40/40AM

STATO DEL RILEVATORE		INDICATORE LED (SOLO ROSSO)
Riscaldamento		 Lampeggia per circa 60 secondi
Allarme		 Si accende per 2 secondi
Uscita di guasto	Avvio anti-mascheramento (Avvio anti-mascheramento)	 Lampeggia 2 volte, si spegne per 5 secondi e poi ripete il ciclo per 180 secondi
	Individuazione di mascheramento	 Lampeggia 3 volte, si spegne per 3 secondi e poi il ciclo si ripete

-HX-40DAM

STATO DEL RILEVATORE		INDICATORE LED
Riscaldamento		 Lampeggia per circa 60 secondi
Allarme		 Il LED rosso si accende per 2 secondi
Rilevamento PIR		 Il LED verde si accende per 2 secondi
Rilevamento MW		 Il LED giallo si accende per 2 secondi
Uscita di guasto	Avvio anti-mascheramento (Avvio anti-mascheramento)	 I LED verde e rosso lampeggiano 2 volte, si spengono per 5 secondi e poi ripetono il ciclo per 180 secondi.
	Individuazione di mascheramento	 I LED verde e rosso lampeggiano 3 volte, si spengono per 3 secondi e poi ripetono il ciclo.

7 CARATTERISTICHE TECNICHE

ENGLISH

FRANÇAIS

DEUTSCH

ITALIANO

ESPAÑOL

PORTUGUÊS

7-1 CARATTERISTICHE TECNICHE

Modello	HX-40	HX-40AM	HX-40DAM
Metodo di rilevamento	A infrarossi, passivo		A infrarossi, passivo e microonde
Copertura PIR	12 m ampiezza 85°/94 zone		
Limite distanza PIR	4,0 m, 5,5 m, 9,0 m		
Velocità rilevabile	Da 0,3 m/s a 1,5 m/s		
Sensibilità	2,0°C a 0,6 m/s		
Alimentazione	Da 9,5 a 18 VDC		
Assorbimento di corrente	35 mA (max.) a 12 VDC	40 mA (max.) a 12 VDC	50 mA (max.) a 12 VDC
Durata allarme	2,0 ±1 s		
Periodo di riscaldamento	Circa 60 secondi (il LED lampeggia)		
Uscita allarme	Modulo C 28 VDC 0,2 A (max.)		
Uscita antimanomissione	N.C. 28 VDC, 0,1 A (max.) N.C. si apre quando viene tolto il coperchio.		
Uscita di guasto	-	N.C. 28 VDC, 0,1 A (max.)	
Ingresso AUX	N.C. 28 VDC, 0,1 A (max.)		
Spia LED	Rosso: Riscaldamento, allarme	Rosso: Riscaldamento, allarme, guasto	Rosso: Riscaldamento, allarme, guasto Verde: Riscaldamento, rilevamento PIR, Guasto Giallo: Riscaldamento, rilevamento MW
Temperatura di esercizio	da -20 a +60°C		
Umidità ambientale	95% (max)		
Resistente agli agenti atmosferici	IP55		
Montaggio	Parete		
Altezza di montaggio	da 2,5 a 3,0 m		
Angolo regolazione squadretta	Verticale: ±20° orizzontale: ±95°		
Peso	600 g	700 g	
Accessori	Squadretta, tettuccio, adesivi di mascheramento aree, viti (3 x 10 mm) x 2, viti (4 x 20 mm) x 4		

*Caratteristiche tecniche e design sono soggetti a modifiche senza preavviso.

7-2 DIMENSIONI

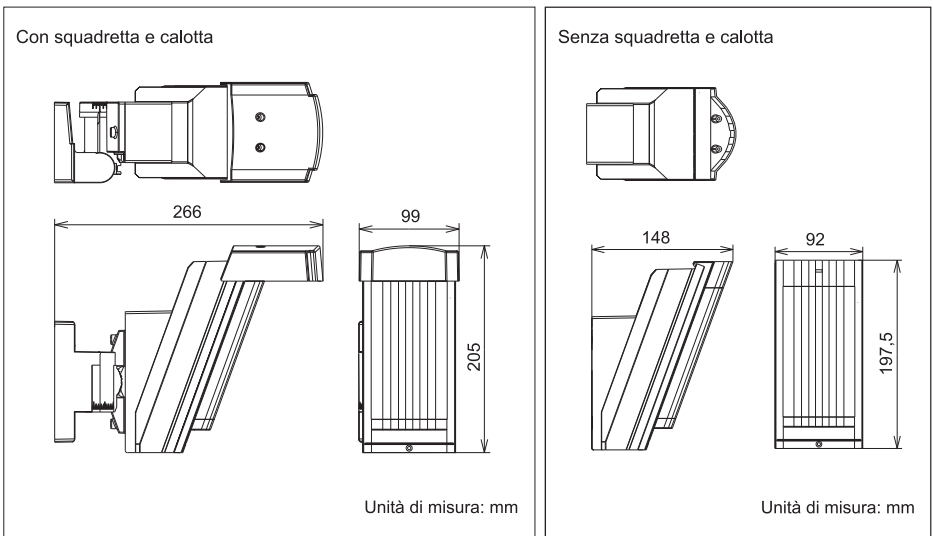

**OPTEX INC. (U.S.)**URL: <http://www.optexamerica.com/>**OPTEX DO BRASIL LTDA. (Brazil)**URL: <http://www.optex.net/br/es/sec/>**OPTEX (EUROPE) LTD. / EMEA HQ (U.K.)**URL: <http://www.optexeurope.com/>**OPTEX CO., LTD. (JAPAN)**URL: <http://www.optex.net/>**OPTEX TECHNOLOGIES B.V.
(The Netherlands)**URL: <http://www.optex.eu/>**OPTEX SECURITY SAS (France)**URL: <http://www.optex-security.com/>**OPTEX SECURITY Sp.z o.o. (Poland)**URL: <http://www.optex.com.pl/>**OPTEX PINNACLE INDIA, PVT., LTD. (India)**URL: <http://www.optex.net/in/en/sec/>**OPTEX KOREA CO.,LTD. (Korea)**URL: <http://www.optexkorea.com/>**OPTEX (DONGGUAN) CO.,LTD.
SHANGHAI OFFICE (China)**URL: <http://www.optexchina.com/>



Detector para exterior de alto montaje
HX-40/40AM/
40DAM

MODELO CABLEADO



HX-40	Modelo standard con dos PIR
HX-40AM	Igual que el HX-40 pero con antimasking
HX-40DAM	Igual que el HX-40AM pero con microondas

CARACTERÍSTICAS

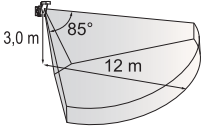

- Montaje a 3,0 m de altura y un área de detección de 12 m.
- Piro-elemento exclusivo de OPTEX.
- Lógica inteligente AND.
- Doble procesamiento de señal.
- Análisis de movimiento de vegetación.
- Área de detección configurable.
- Anti-masking digital (sólo modelos AM/DAM).
- Selector de rango de microondas (MW) (sólo modelo DAM).
- Certificado ETL para UL639 y ULC S306

CONTENTS

1 INTRODUCCIÓN	2-5 TAMPER DE PARED (OPCIONAL) 6
1-1 ANTES DE PONERLO EN FUNCIONAMIENTO ... 1	3 PRUEBA DE FUNCIONAMIENTO (WALK TEST) 7
1-2 IDENTIFICACIÓN DE LAS PARTES 2	4 CONFIGURACIÓN DE PARÁMETROS
1-3 ÁREA DE DETECCIÓN..... 3	4-1 FUNCIÓN 8
2 INSTALACIÓN	5 AJUSTE DEL ÁREA 10
2-1 MONTAJE CON EL SOPORTE 3	6 FUNCIONES DEL INDICADOR LED 10
2-2 AJUSTE DEL ÁNGULO VERTICAL 5	7 ESPECIFICACIONES
2-3 MONTAJE SIN SOPORTE 5	7-1 ESPECIFICACIONES 11
2-4 CABLEADO 6	7-2 DIMENSIONES 11

1 INTRODUCCIÓN

1-1 ANTES DE PONERLO EN FUNCIONAMIENTO

Advertencia	Respete estas instrucciones de seguridad para prevenir daños serios o incluso la muerte.
Precaución	Siga estas precauciones para prevenir potenciales heridas o daños materiales.

La marca indica Recomendación. La marca indica Prohibición.

<p> Advertencia</p> <p>Nunca repare o modifique el producto</p>	<p> Advertencia</p> <p>No vierta agua sobre el producto</p>	<p> Precaución</p> <p>Móntelo de forma segura</p>
<p>Altura de montaje</p> <p>Da 2,5 a 3,0 m (Da 8,2 a 10 ft.)</p>	<p>Mantenga el detector paralelo al suelo.</p> <p>Paralelo</p> <p>Inclinación</p>	<p>Considere la dirección de una persona aproximándose al sensor, así como el área de detección.</p>

Instale el sensor en un lugar adecuado evitando que se produzcan falsas alarmas. Por ejemplo evite:

• Luz solar directa o reflejada



• Fuente de calor

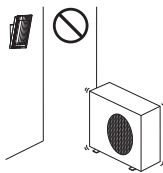

• Objetos que se mueven con el viento

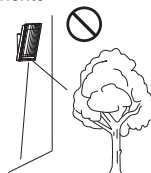

Precauciones para la instalación de dos o más sensores

HX-40
HX-40AM
HX-40DAM

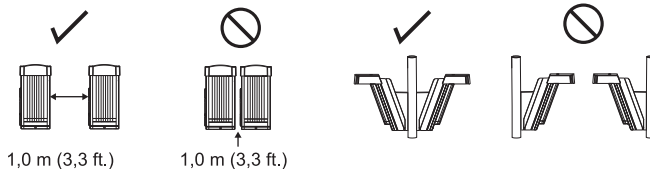

No instale dos o más unidades HX-40DAM juntas en serie o enfrentadas. Hágalo según se indica en la figura:

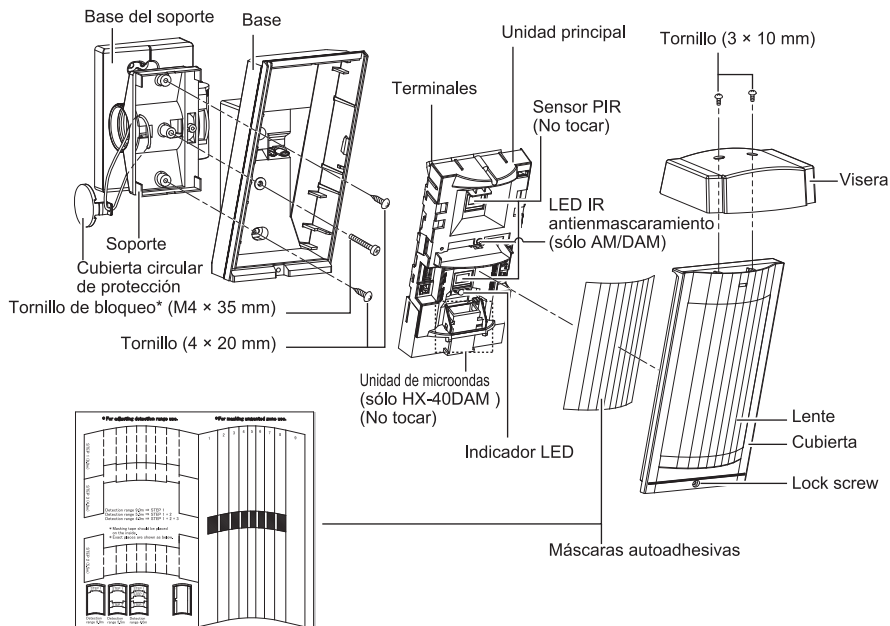

1-2 IDENTIFICACIÓN DE LAS PARTES



Tornillería

Unión	Montaje a pared	Visera
Tornillo (4 x 20 mm) 	Tornillo (4 x 20 mm) 	Tornillo (3 x 10 mm) 

*Apriete el tornillo de la base del soporte

Vista superior del área de detección

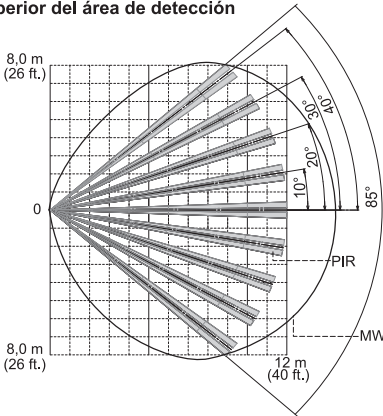

Vista lateral del área de detección

(Altura de instalación 3,0 m (10 ft.))

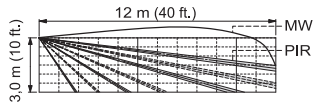

(Altura de instalación 2,5 m (8,2 ft.))

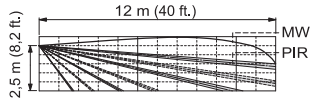

- Ángulo vertical: 1 clic (2,5°) hacia arriba (consulte las precauciones en 2-2)

2 INSTALLATION

Utilice el soporte para instalarlo normalmente. La unidad puede montarse directamente en la pared, sin el soporte, únicamente si se dan estas tres condiciones;

- Altura de montaje de 3,0 m (10 ft.).
- No se requieren ajustes de dirección horizontal
- El suelo está nivelado.

2-1 MONTAJE CON EL SOPORTE

Al utilizar el soporte es posible ajustar la unidad en horizontal $\pm 90^\circ$.

En los casos en los que el suelo no estuviera nivelado o no fuera paralelo a la base, es posible ajustar en vertical $\pm 20^\circ$.

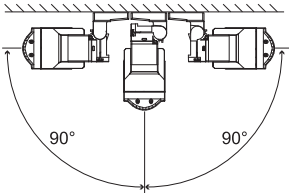

Precauciones>>
No cambie la distancia de detección con el soporte. Use las faldillas y las placas para ajustar la longitud de detección.

- 1** Retire el tornillo de bloqueo arriba-abajo.

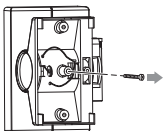

- 2** Presione la traba de la tapa del eje hacia afuera para quitar la tapa del eje.

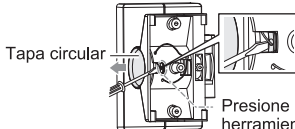

Presione con una herramienta adecuada. por ej. un destornillador pequeño

- 3** Afloje dos vueltas el tornillo de ajuste.

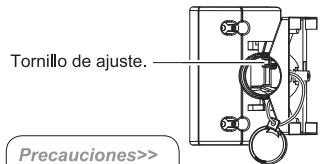

Precauciones>>
No lo afloje demasiado, podría desmontarlo.

- 4 Incline the support 45° and pass the cable.

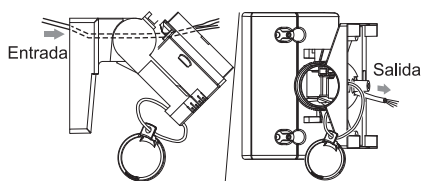

- 6 Open the blind hole for the cable.

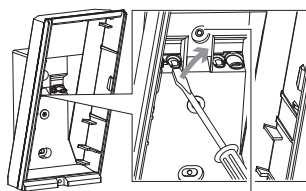

Orificio ciego

- 8 Tighten the screws [1] and [2], adjust the angle of the support (consult the section 3-2), then tighten the screw [3]. In case that it is necessary to perform an adjustment, loosen the screw [3] and change the angle of the support. After the adjustment is performed, tighten the screw again.

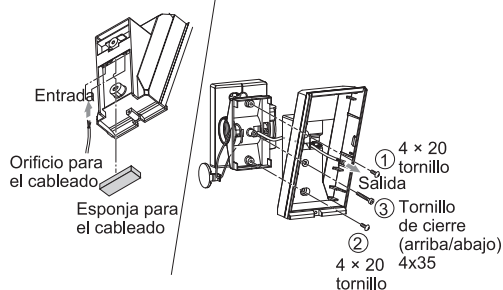

- 10 Place the cable in the terminal and install the main unit and the lens in the base.

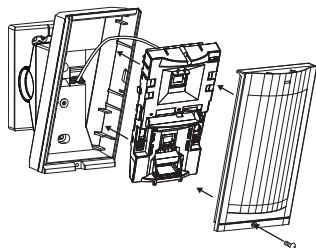

- 5 Determine the horizontal direction (left/right) of the sensor before installing the wall support.

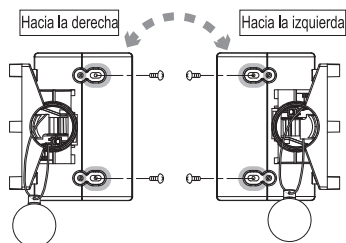

- 7 Open the blind hole of the fastening screw to place the support.

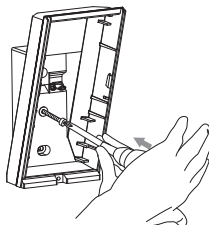

Orificio ciego con un tornillo 4 x 20 (kit de tornillos)

- 9 Tighten the adjustment screw in the direction of the clock hands.

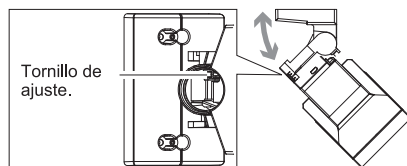

- 11 Place the circular protection cover in its place.

2-2 AJUSTE DEL ÁNGULO VERTICAL

Para conseguir el mejor funcionamiento posible, instale el detector paralelo al suelo. Decida la distancia de detección. Si elige una distancia de 9,0m/5,5m/4,0m, coloque las máscaras autoadhesivas correspondientes.

Realice la prueba de paso para comprobar si el detector se encuentra paralelo al suelo.

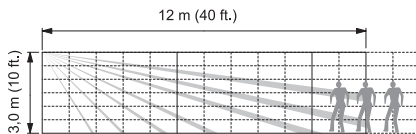

Si sólo se produce la detección dentro de la longitud seleccionada (consulte la página 3), cambie el ángulo vertical hacia arriba.

Si se produce la detección fuera de la longitud seleccionada (consulte la página 3), cambie el ángulo vertical hacia abajo.

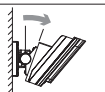
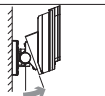

* En el caso que ven a continuación, la longitud de detección es de 12 metros.

Si la detección se produce en el punto justo donde termina la longitud de detección seleccionada, no se necesita hacer más ajustes.

ATENCIÓN>>

Si la base de la unidad ya está paralela al suelo, No cambia la distancia de detección inclinando la unidad hacia arriba o hacia abajo. El área de detección y la longitud deben ajustarse con las máscaras autoadhesivas. Para más detalles, consulte el apartado

Ejemplo (suelo nivelado)

0° es la posición correcta para 3,0 m (10 ft.) altura.

Mueva un clic (2,5° arriba) para una instalación a 2,5 m (8,2 ft.) de altura.

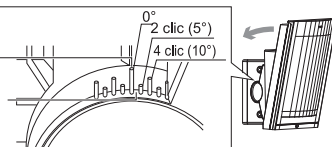

2-3 MONTAJE SIN SOPORTE

- 1 Abra el orificio ciego del cableado con una herramienta adecuada (ej. destornillador).

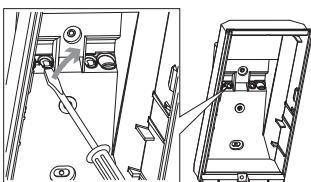

- 2 Pase el cable a través de la base por el orificio.

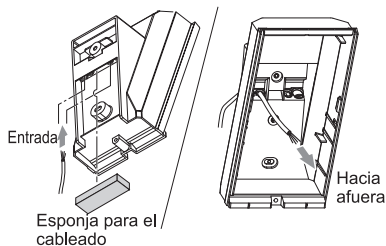

- 3 Sujete la base a la pared.

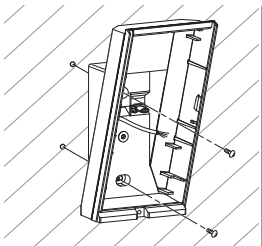

- 4 Instale la unidad principal tras cablear a la terminal.

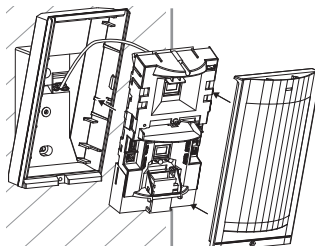

ENGLISH

FRANÇAIS

DEUTSCH

ITALIANO

ESPAÑOL

PORTUGUÊS

2-4 CABLEADO

Los cables de alimentación no deben sobrepasar las siguientes longitudes:

Unidad: mm (ft.)

SECCIÓN CABLE	HX-40		HX-40AM		HX-40DAM	
	12 V	14 V	12 V	14 V	12 V	14 V
AWG22 (0,33 mm ²)	160 (520)	360 (1180)	140 (460)	310 (1020)	120 (390)	250 (820)
AWG20 (0,52 mm ²)	260 (850)	560 (1840)	230 (750)	490 (1610)	180 (590)	390 (1280)
AWG18 (0,83 mm ²)	410 (1350)	900 (2950)	360 (1180)	780 (2560)	290 (950)	630 (2070)

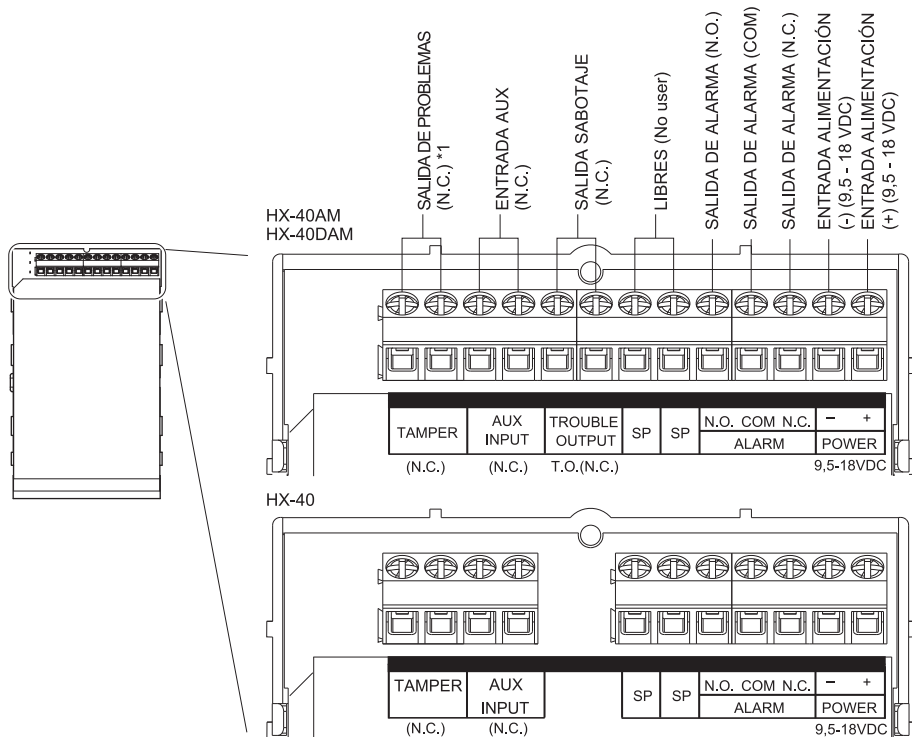

*1: Terminales de TAMPER para conectar a un circuito de supervisión 24 horas.

2-5 TAMPER DE PARED (OPCIONAL)

El interruptor magnético universal debe montarse como un tamper de pared.

En la parte posterior de la unidad principal y del soporte existe un hueco para su instalación de interruptor magnético. El tamaño máximo del interruptor magnético es: D 9 x W 40 x H 9 mm (D 0,35 x W 1,57 x H 0,35 inches)

Unidad Principal



Posición del interruptor magnético (lado de la pared)

Posición del interruptor magnético (lado de la base)

Soporte

Orificio para el cableado

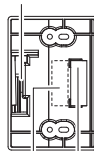

Posición del interruptor magnético (lado de la pared)

Posición del interruptor magnético (lado de la base)

-Instalación

- 1 Instale el interruptor magnético universal a la pared. Para determinar la posición de instalación, utilice la plantilla incluida en la caja del producto.
- 2 Abra el orificio ciego del cableado con una herramienta adecuada (ej. destornillador).

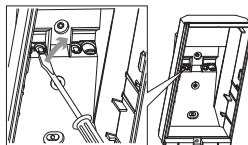
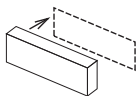

- 3 Instale la otra parte del interruptor magnético en la parte posterior de la unidad principal o el soporte. Pase el cable a través de los orificios.

Si no utiliza el soporte

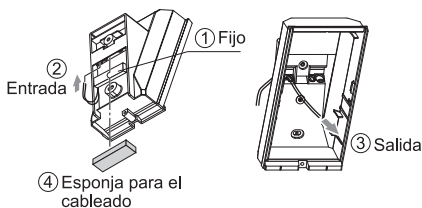

Si utiliza el soporte

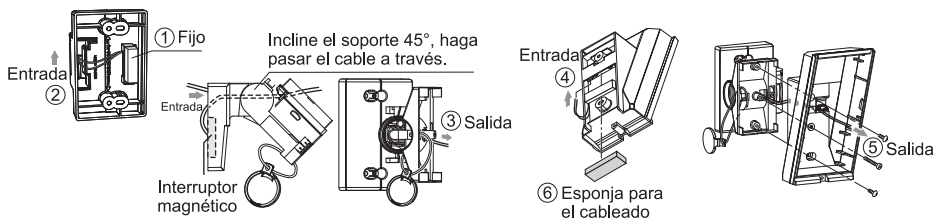

- 4 Instale el soporte y la unidad principal en la superficie de la pared.
- 5 Conecte el cable del interruptor magnético al terminal anti-sabotaje de la unidad principal.

3 PRUEBA DE FUNCIONAMIENTO (WALK TEST)

- 1 Ponga el conmutador DIP 1 (LED ON/OFF) a "ON (TEST)".
- 2 Compruebe que el sensor detecta un objeto en el área de detección. La instalación es correcta si el LED luce durante 2 s después de que una persona cruce el área de detección.
- 3 Si el LED no se enciende siempre que pase, ponga el conmutador DIP 1 (LED ON/OFF) en "OFF".

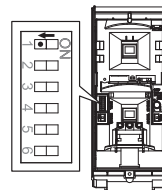
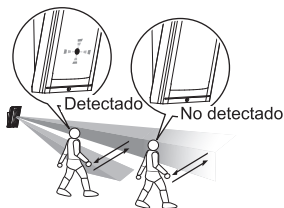
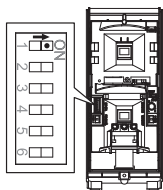

Nota>>

El switch está en "ON" por defecto.

Nota>>

- Para realizar la prueba de funcionamiento, muévase a más de 1,0 m (3,3 ft.) del sensor.
- Realice una prueba de paso al menos una vez al año.

4 CONFIGURACIÓN DE PARÁMETROS

4-1 FUNCIÓN

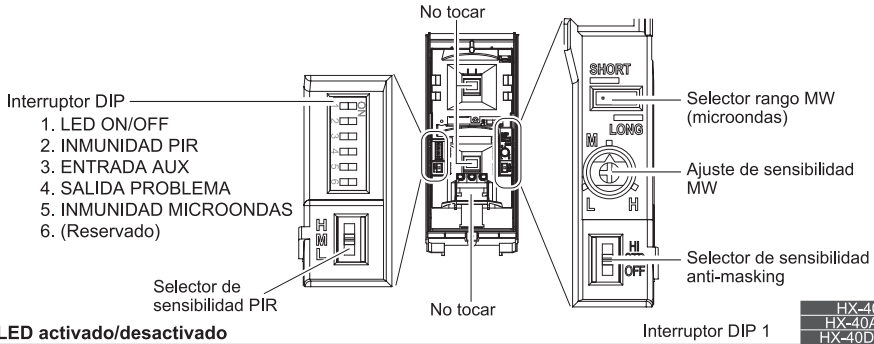

-LED activado/desactivado

Interruptor DIP 1

HX-40
HX-40AM
HX-40DAM



DESACTIVADO ↔ ACTIVADO

POSICIÓN	FUNCIÓN
ACTIVADO (Configuración por defecto)	El LED se ilumina cuando se detecta a alguien.
DESACTIVADO	El LED no se ilumina aunque se detecte a alguien.

-INMUNIDAD PIR

Interruptor DIP 2

HX-40
HX-40AM
HX-40DAM



STD ↔ INMUNIDAD

POSICIÓN	FUNCIÓN
STD (Configuración por defecto)	La lógica de INMUNIDAD PIR no está activada.
INMUNIDAD	La lógica de INMUNIDAD PIR está activada. Utilícelo bajo condiciones adversas (por ej. en presencia de animales pequeños).

-ENTRADA AUX

Interruptor DIP 3

HX-40
HX-40AM
HX-40DAM

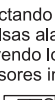

Y ↔ O

POSICIÓN	FUNCIÓN
Y (Configuración por defecto)	Cuando la unidad principal y la satélite detectan algo, se genera una alarma. Póngalo en esta posición cuando no se conecte una unidad satélite.
O	Cuando la unidad principal o la satélite detectan algo, se genera una alarma.

Notas>>

- La alarma no se produce a menos que ambas unidades (principal y satélite) detecten algo en 60 s.
- Si el modo OR está seleccionado y no hay unidad satélite conectada, e generará una alarma continua.

-SALIDA DE INCIDENCIA

Interruptor DIP 4

HX-40
HX-40AM
HX-40DAM

La salida de problemas se utiliza para la señal anti-enmascaramiento (o Anti-masking). Cuando un objeto se sitúa cerca de la superficie de la lente durante más de 180 segundos, el circuito infrarrojo de anti-enmascaramiento se activará y generará una señal de problema.



DESACTIVADO ↔ ACTIVADA

POSICIÓN	FUNCIÓN
ACTIVADA (Configuración por defecto)	El terminal de salida de Incidencia emite señales de anti-enmascaramiento.
DESACTIVADO	Salidas desde ambos terminales, el de Incidencia y el de Alarma.

Notas>>

Use esto cuando no esté cableada la entrada problema en el panel de control.

-INMUNIDAD A MICROONDAS

Interruptor DIP 5

HX-40
HX-40AM
HX-40DAM



STD ↔ INMUNIDAD

POSICIÓN	FUNCIÓN
STD (Configuración por defecto)	La lógica Inmunidad microondas no está activada.
INMUNIDAD	La lógica Inmunidad microondas está activada. Use esto ante movimientos bruscos (ej. vegetación).

-SELECTOR RANGO MW/ AJUSTE SENSIBILIDAD MW

SELECTOR RANGO/AJUSTE SENSIBILIDAD

HX-40
HX-40AM
HX-40DAM

ÁREA PIR	ÁREA DE DETECCIÓN (VISTA LATERAL)	SELECTOR RANGO MW	AJUSTE SENSIBILIDAD MW
12 m (40 ft.) Factory default		LONG - LARGO 	M - MEDIO
9,0 m (30 ft.) 		SHORT - ORTO 	H - ALTO
5,5 m (18 ft.) 		SHORT - ORTO 	M - MEDIO
4,0 m (13 ft.) 		SHORT - ORTO 	L - BAJA

-SENSIBILIDAD PIR

SELECTOR DE SENSIBILIDAD PIR

HX-40
HX-40AM
HX-40DAM

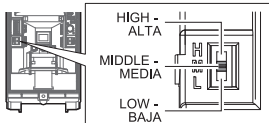

POSITION	FUNCTION
HIGH - ALTA	Sensibilidad Alta
MIDDLE - MEDIA (Factory default)	Sensibilidad Media
LOW - BAJA	Sensibilidad Baja

-SENSIBILIDAD ANTI-MASKING

SELECTOR DE SENSIBILIDAD ANTI ENMASCARAMIENTO

HX-40
HX-40AM
HX-40DAM

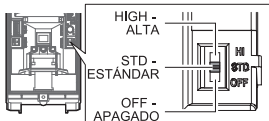

POSITION	FUNCTION
HIGH - ALTA	Sensibilidad Alta
STD - ESTÁNDAR (Factory default)	Sensibilidad Estándar
OFF - APAGADO	Deshabilitada

Precaución>>

Cuando cierre la cubierta, no deje ningún objeto a menos de 1,0 m (3,3 ft.) de la unidad.

ENGLISH

FRANÇAIS

DEUTSCH

ITALIANO

ESPAÑOL

PORTUGUÊS

5 AJUSTE DEL ÁREA

-Ajuste del Alcance de Detección

Para limitar el rango de detección, coloque la máscara autoadhesiva dentro de la lente, en la sección que desee ocultar. Note que hay tres tipos distintos de sellado.

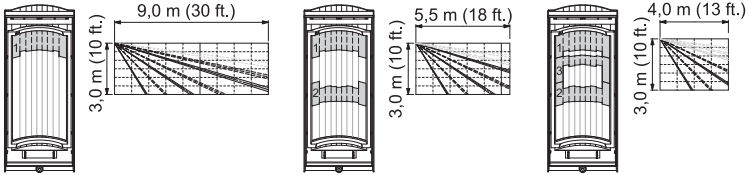

-ÁREA DE MASKING

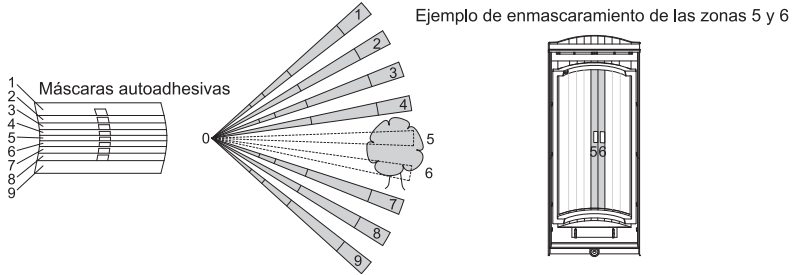

6 LED INDICATION

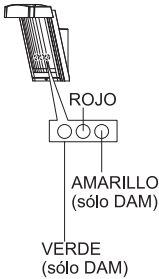

-HX-40/40AM

ESTADO DEL DETECTOR		Indicación del LED (sólo ROJO)
Calentamiento		→ Parpadea durante 60 s aprox.
Alarma		→ Se enciende fijo durante 2 s
Salida sabotaje	Comienzo del anti-mascaramiento (inicio anti-masking)	→ → → Parpadea 2 veces, se apaga durante 5 seg. y repite el ciclo durante 180 seg.
	Anti-mascaramiento	→ → → → Parpadea 3 veces, se apaga durante 3 seg. y repite el ciclo

-HX-40DAM

ESTADO DEL DETECTOR		Indicación del LED
Calentamiento		→ Parpadea durante 60 s aprox.
Alarma		→ Se enciende fijo en ROJO durante 2 s
Detección PIR		→ Se enciende fijo en VERDE durante 2 s
Detección MW		→ Se enciende fijo en AMARILLO durante 2 s
Salida sabotaje	Comienzo del anti-mascaramiento (inicio anti-masking)	→ → → Verde y Rojo parpadean 2 veces, se apagan durante 5 seg. y repiten el ciclo durante 180 seg.
	Anti-mascaramiento	→ → → → Verde y Rojo parpadean 3 veces, se apagan durante 3 seg. y repiten el ciclo.

7 ESPECIFICACIONES

7-1 ESPECIFICACIONES

Modelo	HX-40	HX-40AM	HX-40DAM
Método de detección	Infrarrojos pasivos		Infrarrojo pasivo y microondas
Cobertura PIR	12 m (40 ft.) 85° ancho / 94 zonas		
Límite de distancia PIR	4,0 m, 5,5 m, 9,0 m (13 ft., 18 ft. 30 ft.)		
Velocidad detectable	0,3 m/s – 1,5 m/s (1 ft./s – 5 ft./s)		
Sensibilidad	2,0°C (3,6°F) a 0,6 m/s		
Entrada	9,5 – 18 VDC		
Consumo de corriente	35 mA (máx) a 12 VDC	40 mA (máx) a 12 VDC	50 mA (máx) a 12 VDC
Periodo de alarma	2,0 ±1 seg.		
Periodo de calentamiento	60 seg. aprox. (el indicador LED parpadea)		
Salida de alarma	Forma C, 28 VDC 0,2A máx.		
Salida sabotaje	N.C. 28 VDC, 0,1A máx. N.C. abierto al quitar la cubierta		
Entrada auxiliar	–	N.C. 28 VDC, 0,1A máx.	
Entrada auxiliar	N.C. 28 VDC, 0,1A máx.		
Indicador LED	Rojo: Calentamiento, Alarma	Rojo: Calentamiento, Alarma, Problemas	Rojo: Calentamiento, Alarma, Problemas Verde: Calentamiento, Detección PIR, Problemas Amarillo: Calentamiento, Detección MW
Temperatura de trabajo	-20°C – +60°C (-4°F – +140°F)		
Humedad ambiente	95% máx.		
Resistente al agua	IP55		
Montaje	Pared		
Altura de montaje	2,5 – 3,0 m (8,2 – 10 ft.)		
Ángulo de ajuste del soporte	Vertical: ±20° Horizontal: ±95°		
Peso	600 g (21,2 oz.)		700 g (24,7 oz.)
Accesorios	Soporte, visera, máscaras autoadhesivas, tornillos × 2 (3 × 8 mm), tornillos × 4 (4 × 20 mm)		

* Las especificaciones y el diseño están sujetas a cambio sin previo aviso.

7-2 DIMENSIONES

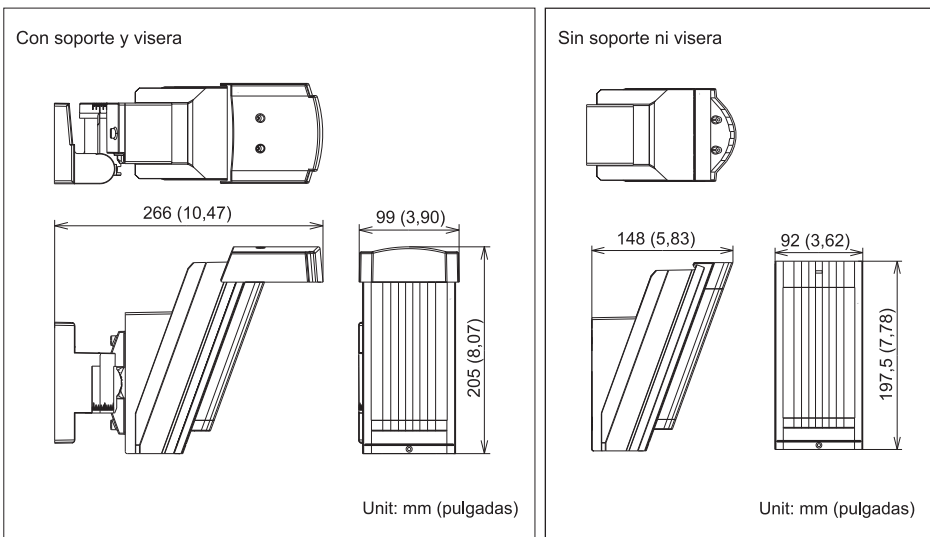

**OPTEX INC. (U.S.)**URL: <http://www.optexamerica.com/>**OPTEX DO BRASIL LTDA. (Brazil)**URL: <http://www.optex.net/br/es/sec/>**OPTEX (EUROPE) LTD. / EMEA HQ (U.K.)**URL: <http://www.optexeurope.com/>**OPTEX CO., LTD. (JAPAN)**URL: <http://www.optex.net/>**OPTEX TECHNOLOGIES B.V.
(The Netherlands)**URL: <http://www.optex.eu/>**OPTEX SECURITY SAS (France)**URL: <http://www.optex-security.com/>**OPTEX SECURITY Sp.z o.o. (Poland)**URL: <http://www.optex.com.pl/>**OPTEX PINNACLE INDIA, PVT., LTD. (India)**URL: <http://www.optex.net/in/en/sec/>**OPTEX KOREA CO.,LTD. (Korea)**URL: <http://www.optexkorea.com/>**OPTEX (DONGGUAN) CO.,LTD.
SHANGHAI OFFICE (China)**URL: <http://www.optexchina.com/>



Detector para ambientes externos para montagem em pontos elevados

**HX-40/40AM/
40DAM**

MODELO COM FIO

HX-40	Modelo padrão com 2 PIRs
HX-40AM	HX-40 com função antimascaramento
HX-40DAM	HX-40AM com microondas

CARACTERÍSTICAS

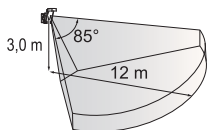

- Área de detecção à uma altura de montagem de 3,0 m (12 m)
- Piroelemento exclusivo
- Lógica E Inteligência
- Lógica de processamento de sinal duplo
- Lógica de análise de movimento da vegetação
- Ajuste ideal da área de detecção
- Função de antimascaramento digital (somente nos modelos AM/DAM)
- Seletor de alcance das microondas (somente no modelo DAM)
- Certificado ETL para UL639 e ULC S306

ÍNDICE

1 INTRODUÇÃO			
1-1 ANTES DE OPERAR	1	2-5 TAMPER PARA INSTALAÇÃO NA PAREDE (OPCIONAL)	6
1-2 ANTES DA INSTALAÇÃO	2	3 TESTE DE CAMINHADA	7
1-3 IDENTIFICAÇÃO DAS PARTES	3	4 AJUSTE	
2 INSTALAÇÃO		4-1 FUNÇÃO	8
2-1 MONTAGEM COM O USO DE UM SUPORTE	3	5 ÁREA ADJUSTMENT	10
2-2 AJUSTE DO ÂNGULO VERTICAL	5	6 INDICAÇÃO POR LED	10
2-3 MONTAGEM SEM O USO DE UM SUPORTE	5	7 ESPECIFICAÇÕES	
2-4 FIAÇÃO	6	7-1 ESPECIFICAÇÕES	11
		7-2 DIMENSÕES	11

1 INTRODUÇÃO

1-1 ANTES DE OPERAR

Advertência	Não seguir as instruções fornecidas com esta indicação e uma manipulação inadequada pode causar ferimentos graves ou até a morte.
Cuidado	Não seguir as instruções fornecidas com esta instalação e uma manipulação inadequada pode causar ferimentos e/ou danos à propriedade.

La marca indica Recomendación.

La marca indica Prohibición.

<p> Advertência</p> <p>Não repare ou modifique o produto</p>	<p> Advertência</p> <p>Mantenha o produto afastado da água</p>	<p> Cuidado</p> <p>Monte a unidade firmemente</p>
<p>Altura da montagem</p> <p>2,5 a 3,0 m (8,2 a 10 ft.)</p>	<p>Mantenha o detector paralelo ao solo.</p> <p>Paralelo</p> <p>Inclinação</p>	<p>Considere a direção pela qual uma pessoa está se aproximando, bem como a área de detecção.</p>

Instale o detector em um local onde não possam existir fatores geradores de alarmes falsos. Por exemplo:

• Luz solar e reflexos



• Fontes de aquecimento

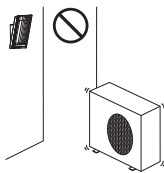

• Objetos se movendo com o vento

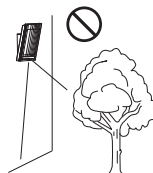

-Precauções sobre a instalação de dois ou mais sensores

HX-40
HX-40AM
HX-40DAM

Não instale duas ou mais unidades HX-40DAM lado-a-lado ou face-a-face. Ao invés disso, instale-as de costas uma para outra. Se montar na mesma parede, certifique-se de afastar em pelo menos 1,0 m uma unidade da outra.

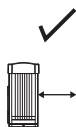

1,0 m (3,3 ft.) ou mais



Inferior a 1,0 m (3,3 ft.)

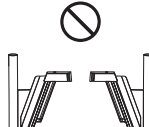

1-2 IDENTIFICAÇÃO DAS PARTES

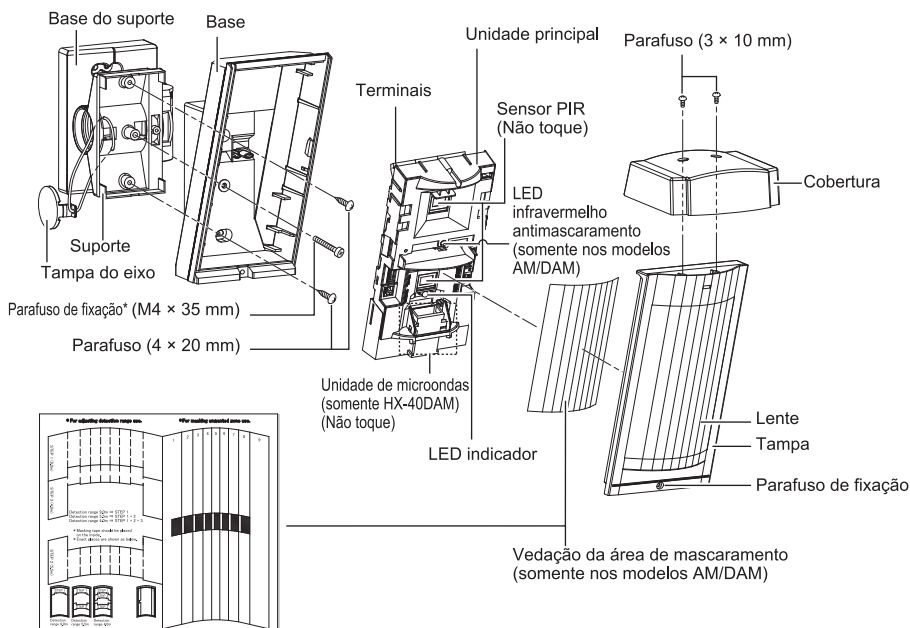

Kit de parafusos

Para junção	Para montagem em parede	Para o suporte
Parafuso (4 × 20 mm)	Parafuso (4 × 20 mm)	Parafuso (3 × 10 mm)

*Parafuso de fixação fixado na base do suporte

Vista superior

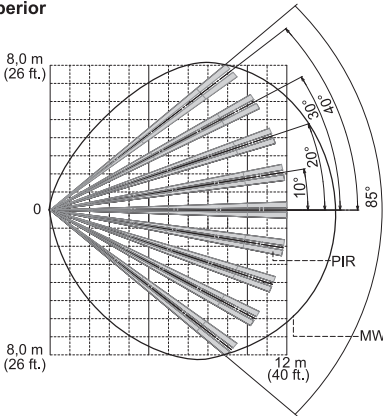

Vista lateral

(Altura da montagem: 3,0 m (10 ft.))

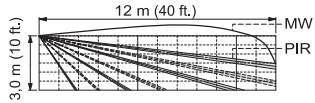

(Mounting height: 2,5 m (8,2 ft.))

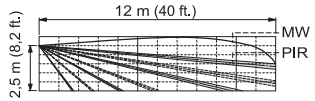

- Ângulo vertical: 1 clique (2,5°) para cima (Refira-se à seção "cuidados" na seção 2-2).

2 INSTALAÇÃO

Utilize o suporte para uma instalação normal. A unidade pode ser montada diretamente na parede, sem o suporte, somente se as três condições a seguir forem satisfeitas;

- Altura de montagem: 3,0 m (10 ft.).
- Nenhum ajuste da direção horizontal é necessário
- O solo está nivelado.

2-1 MONTAGEM COM O USO DE UM SUPORTE

A utilização do suporte torna possível ajustar a unidade horizontalmente em $\pm 90^\circ$.

Nos casos em que o piso está desnivelado e/ou não está em paralelo com a base da unidade, é possível ajustar a unidade verticalmente em 20.

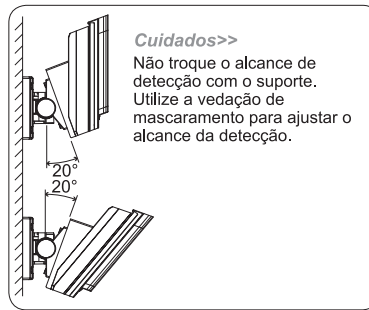
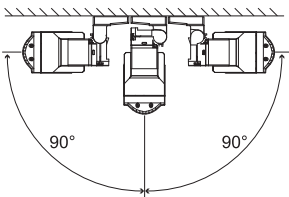

- 1 Remova o parafuso de fixação de cima para baixo.
- 2 Pressione o prendedor da tampa do eixo para fora para remover a tampa.
- 3 Afrouxe o parafuso de ajuste em duas voltas.

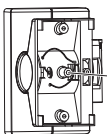

Tampa do eixo

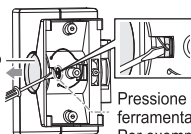

Pressione com uma ferramenta adequada. Por exemplo, uma chave de fenda pequena

Parafuso de ajuste.

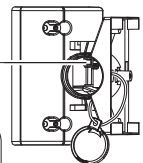

Cuidados>>

Não afrouxe muito o parafuso, já que isto pode desmontar o equipamento.

- 4 Incline o suporte em 45° e passe o fio por ele.

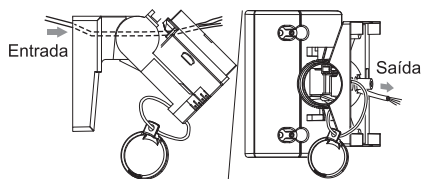

- 6 Abra o entalhe da fiação.

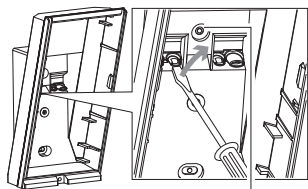

Entalhe da fiação

- 8 Aperte os parafusos ① e ②, ajuste o ângulo do suporte (refira-se ao item 2-2) e em seguida aperte o parafuso ③. Execute uma verificação da área. Se um reajuste for necessário, solte o parafuso 3 e troque o ângulo do suporte. Após a conclusão do ajuste, aperte o parafuso 3 novamente.

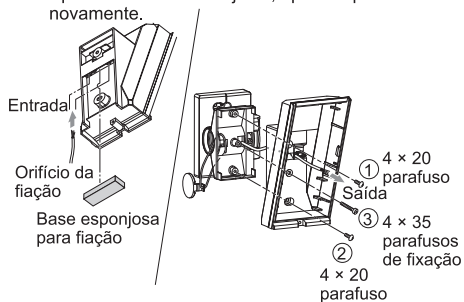

- 10 Instale o fio até o terminal e instale a unidade principal e a lente na base.

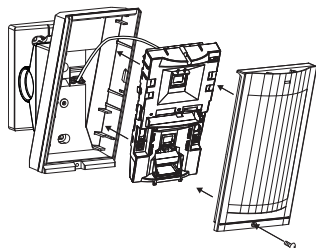

- 5 Determine a direção horizontal (esquerda ou direita) do detector antes de instalar o suporte na parede.

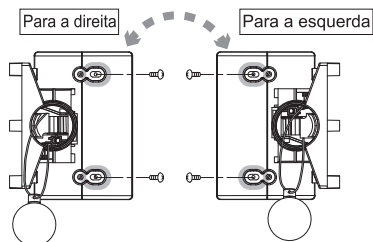

- 7 Abra o entalhe do parafuso de fixação para conectar o suporte.

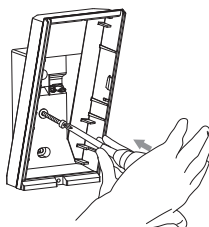

Entalhe com parafuso auto-atarrachante 4 x 20 (kit de parafusos)

- 9 Aperte o parafuso de ajuste em sentido horário.

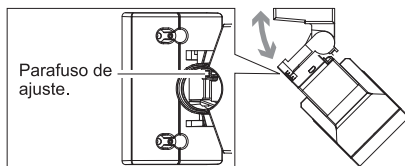

- 11 Instale a tampa do eixo no lugar.

2-2 AJUSTE DO ÂNGULO VERTICAL

Para melhor desempenho, instale o detector paralelamente ao solo.
Defina o alcance da detecção. Se você selecionar 9,0 m/5,5 m/4,0 m, aplique a máscara de vedação às lentes desnecessárias com vedações de mascaramento.

Realize o teste de caminhada para verificar se o detector está em paralelo com o solo.

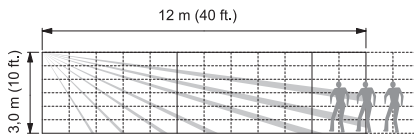

* Este é o caso típico para obter um alcance de detecção de 12 m.

Se o alcance da detecção for inferior àquele designado (refira-se à página 3), ajuste o ângulo detector para cima.

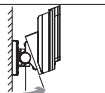

Se o alcance da detecção for superior àquele designado (refira-se à página 3), ajuste o ângulo do detector para baixo.

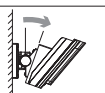

Se o alcance da detecção for igual àquele designado, os ajustes foram concluídos.

Cuidado>>

Se a base da unidade já estiver paralela ao solo.

- Não troque o alcance de detecção inclinando a unidade para cima ou para baixo. O alcance de detecção deve ser ajustado com a vedação de mascaramento instalada. Refira-se às seções 2-1 para detalhes.

Exemplo (o solo está nivelado)

0° é o ajuste correto para uma instalação à uma altura de 3,0 m (10 ft.).

Ajuste 1 clique (2,5° para cima) para uma instalação à uma altura de 2,5 m (8,2 ft.)

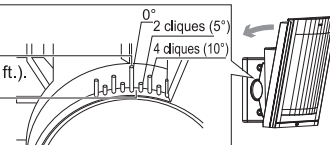

2-3 MONTAGEM SEM O USO DE UM SUPORTE

- 1 Abra o entalhe da fiação com uma ferramenta adequada, p. ex. uma chave de fenda.

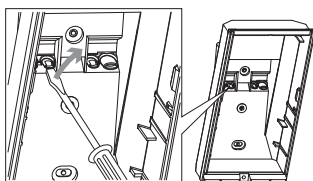

- 2 Puxe a fiação pelo entalhe da base.

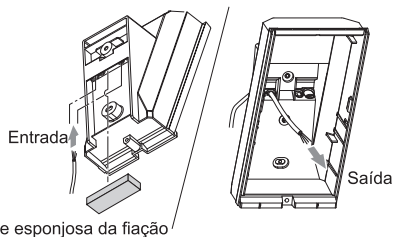

- 3 Fixe a base à parede

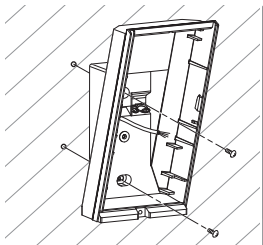

- 4 Instale a unidade principal após finalizar a fiação do terminal.

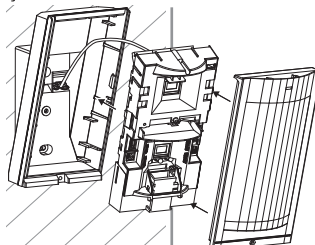

2-4 FIAÇÃO

Os fios de energia não devem ultrapassar os comprimentos a seguir.

Unidade: mm (ft.)

WIRE GAUGE	HX-40		HX-40AM		HX-40DAM	
	12 V	14 V	12 V	14 V	12 V	14 V
AWG22 (0,33 mm ²)	160 (520)	360 (1180)	140 (460)	310 (1020)	120 (390)	250 (820)
AWG20 (0,52 mm ²)	260 (850)	560 (1840)	230 (750)	490 (1610)	180 (590)	390 (1280)
AWG18 (0,83 mm ²)	410 (1350)	900 (2950)	360 (1180)	780 (2560)	290 (950)	630 (2070)

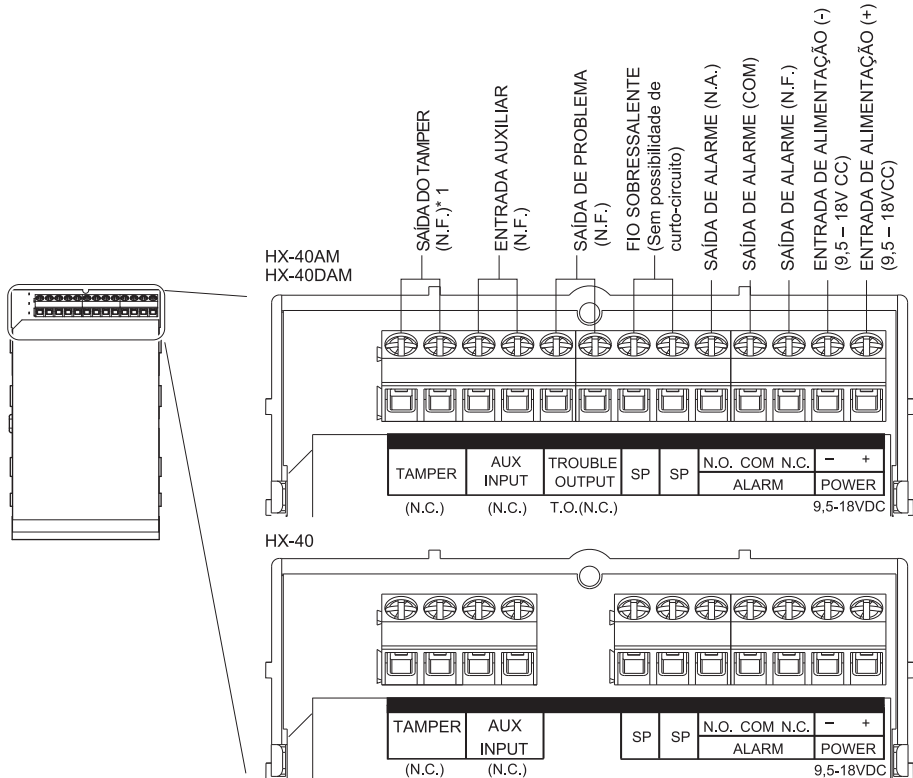

*1: Terminais do TAMPER a serem conectados a um circuito supervisionado de 24 horas.

2-5 WALL TAMPER (OPTION)

O interruptor magnético universal deve ser montado como um tamper de parede.

Um espaço de instalação para o interruptor magnético universal está localizado na parte traseira da unidade principal e do suporte. Tamanho máximo de um interruptor magnético universal aplicável: P 9 x L 40 x A 9 mm (P 0,35 x L 1,57 x A 0,35 inches)

O interruptor magnético universal não está incluído.

Unidade principal



Posição do interruptor magnético (lateral da parede)

Posição do interruptor magnético (lateral da base)

Suporte

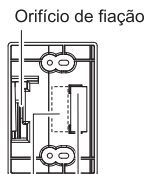

Posição do interruptor magnético (lateral da parede)

Posição do interruptor magnético (lateral da base)

-Instalação

- 1 Instale o interruptor magnético universal (seção da parede) na parede. Para determinar a posição de instalação, utilize o "gabarito da posição de instalação" fornecido na tampa interna da embalagem do produto.
- 2 Abra o entalhe da fiação com uma ferramenta adequada, p. ex. uma chave de fenda.

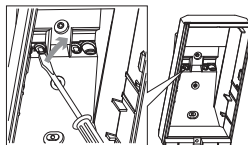
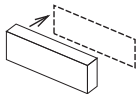

- 3 Instale a outra parte do interruptor magnético na parte traseira da unidade principal ou do suporte. Passe a fiação através dos entalhes.

Quando não utilizar o suporte

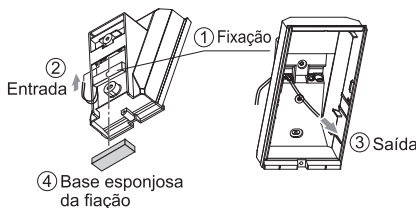

Quando utilizar o suporte

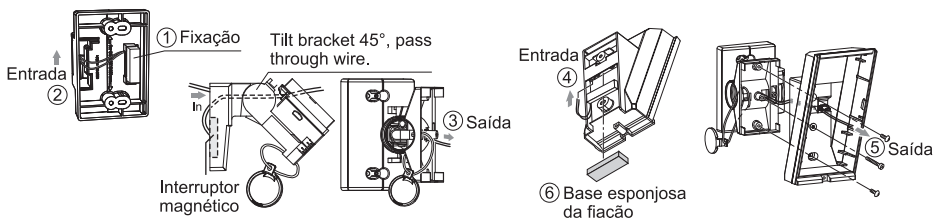

- 4 Instale o suporte e a unidade principal à superfície de uma parede.
- 5 Conecte a fiação do interruptor magnético ao terminal do tampo da unidade principal.

3 TESTE DE CAMINHADA

- 1 Ajuste a chave DIP 1 (LED ON/OFF) para "ON".
- 2 Verifique se o detector detecta um objeto na área de detecção pretendida. Uma instalação realizada com sucesso é indicada se o LED for aceso por dois segundos após uma pessoa caminhar pela área de detecção.
- 3 Se a indicação do LED não for necessária continuamente, ajuste a chave DIP 1 (LED ON/OFF) para "OFF".

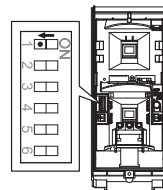
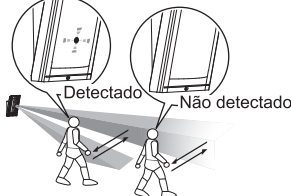
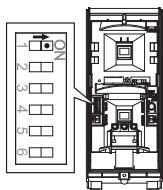

Nota>>

A chave é ajustada para "ON" como padrão de fábrica.

Nota>>

- Para o teste de caminhada, caminhe em uma distância além de 1,0 metro (3,3 ft.) afastada do detector.
- Conduza um teste de caminhada pelo menos uma vez por ano.

4 AJUSTES

4-1 FUNÇÃO

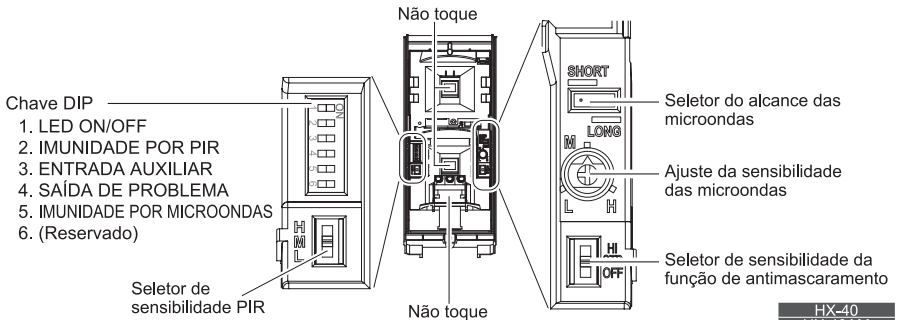

-LED ON/OFF

HX-40
HX-40AM
HX-40DAM



APAGADO ↔ ACESO

POSIÇÃO	FUNÇÃO
ACESO (padrão de fábrica)	O LED será aceso quando alguém for detectado.
APAGADO	O LED não é aceso mesmo que alguém seja detectado.

-PIR IMMUNITY

Chave DIP 2

HX-40
HX-40AM
HX-40DAM



STD ↔ IMUNIDADE

POSIÇÃO	FUNÇÃO
STD (padrão de fábrica)	A lógica IMUNIDADE POR PIR não está ativada.
IMUNIDADE	A lógica IMUNIDADE POR PIR está ativada. Utilize esta função em ambientes hostis (p. exemplo, na possibilidade da presença de pequenos animais).

-ENTRADA AUXILIAR

Chave DIP 3

HX-40
HX-40AM
HX-40DAM



E ↔ OU

POSIÇÃO	FUNÇÃO
E (padrão de fábrica)	Quando a unidade principal e o satélite detectarem alguém, o alarme será transmitido. Ajuste para este parâmetro quando não conectar uma unidade satélite.
OU	Quando a unidade principal ou o satélite detectar alguém, o alarme será transmitido.

Notas>>

- O alarme não será transmitido exceto se a unidade principal e o satélite detectarem alguém dentro de 60 segundos.
- Se o modo OR (OU) for selecionado sem uma unidade satélite conectada, o alarme será gerado continuamente.

-SAÍDA DE PROBLEMA

Chave DIP 4

HX-40
HX-40AM
HX-40DAM

A saída de problema é utilizada para o sinal anti-mascaramento. Quando um objeto permanecer próximo à superfície da lente por um período superior a 180 segundos, o circuito de anti-mascaramento IR será ativado e irá gerar um sinal de problema.

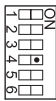

DESATIVADO ↔ ATIVADO

POSIÇÃO	FUNÇÃO
ATIVADO (padrão de fábrica)	Saídas do sinal de antimascaramento a partir do terminal de saída de problema.
DESATIVADO	Saídas dos terminais de saída Trouble (Problema) e Alarm (Alarme).

Notas>>

Utilize este procedimento quando não fizer o cabeamento de um terminal de entrada de problema detectado no painel de controle.

-IMUNIDADE POR MICROONDAS

Chave DIP 5

HX-40
HX-40AM
HX-40DAM



STD ↔ IMUNIDADE

POSIÇÃO	FUNÇÃO
STD (padrão de fábrica)	A lógica MICRO WAVE IMMUNITY (IMUNIDADE ÀS ONDAS DE MICROONDAS) não será ativada.
IMUNIDADE	A lógica MICRO WAVE IMMUNITY (IMUNIDADE ÀS ONDAS DE MICROONDAS) será ativada. Utilize este ajuste em ambientes severos (p. ex. movimento de vegetação).

-ELETOR DE ALCANCE DAS MICROONDAS / AJUSTE DA SENSIBILIDADE POR MICROONDAS

SELETOR DE ALCANCE/AJUSTE DA SENSIBILIDADE

HX-40
HX-40AM
HX-40DAM

AJUSTE DA ÁREA PIR	ÁREA DE DETECÇÃO (VISTA LATERAL)	SELETOR DE ALCANCE POR MICROONDAS	AJUSTE DA SENSIBILIDADE POR MICROONDAS
12 m (40 ft.) Factory default		LONGO 	MÉDIO
9,0 m (30 ft.) 		CURTO 	ALTO
5,5 m (18 ft.) 		CURTO 	MÉDIO
4,0 m (13 ft.) 		CURTO 	BAIXO

-SENSIBILIDADE POR PIR

SELETOR DE SENSIBILIDADE PIR

HX-40
HX-40AM
HX-40DAM

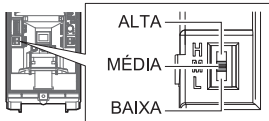

POSIÇÃO	FUNÇÃO
ALTA	Sensibilidade alta
MÉDIA (Padrão de fábrica)	Sensibilidade média
BAIXA	Sensibilidade baixa

-SENSIBILIDADE DA FUNÇÃO ANTIMASCARAMENTO

SELETOR DE SENSIBILIDADE DA FUNÇÃO ANTI-MASCARAMENTO

HX-40
HX-40AM
HX-40DAM

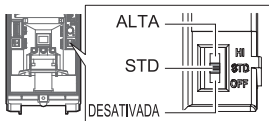

POSIÇÃO	FUNÇÃO
ALTA	Sensibilidade alta
STD (Padrão de fábrica)	Sensibilidade padrão
DESATIVADA	Desabilitada

Cuidado>>

Quando fechar a tampa, não deixe qualquer objeto à distância de 1,0 m (3,3 ft.) da unidade

5 AJUSTE DA ÁREA

-Ajuste da extensão da detecção

Para limitar o alcance de detecção, aplique a vedação de mascaramento apropriada. Note que há três diferentes tipos de vedações

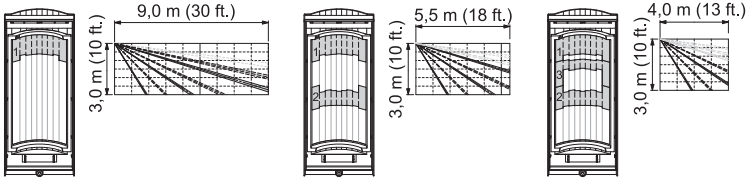

-ÁREA DE MASCARAMENTO

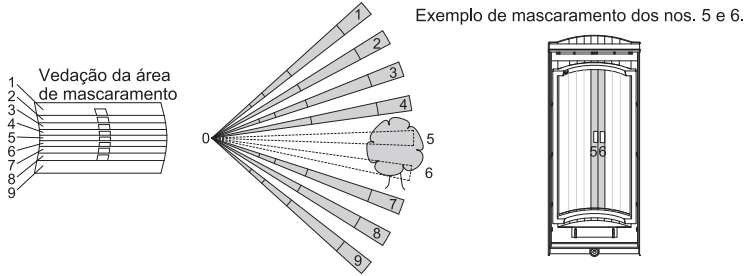

6 INDICAÇÃO POR LED

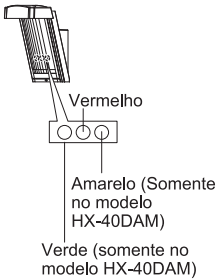

-HX-40/40AM

CONDIÇÕES DO DETECTOR		LED INDICADOR (SOMENTE VERMELHO)
Aquecimento		→ → Pisca durante aproximadamente 60 segundos
Alarme		→ Acende por 2 segundos
Saída de problema	Inicialização da função anti-mascaramento. (Ativação da função de antimascaramento)	→ → → Pisca 2 vezes, apaga por 2 segundos e em seguida repete por 180 segundos
	Deteção de mascaramento	→ → → Pisca 3 vezes, apaga por 3 segundos e em seguida repete

-HX-40DAM

CONDIÇÕES DO DETECTOR		LED INDICADOR
Aquecimento		→ → → Pisca durante aproximadamente 60 segundos
Alarme		→ → Acende em vermelho por 2 segundos
Deteção PIR		→ → Acende em verde por 2 segundos
Deteção MW		→ → → Acende em amarelo por 2 segundos
Saída de problema	Inicialização da função anti-mascaramento. (Ativação da função de antimascaramento)	→ → → → Pisca em verde e vermelho 2 vezes, apaga por 5 segundos e repete por 180 segundos.
	Deteção de mascaramento	→ → → → → Pisca em verde e vermelho 3 vezes, apaga por 3 segundos e repete.

7 ESPECIFICAÇÕES

7-1 ESPECIFICAÇÕES

Modelo	HX-40	HX-40AM	HX-40DAM
Método de detecção	Infravermelho passivo		Infravermelho passivo e Microondas
Cobertura PIR	12 m (40 ft.) 85° de largura / 94 zonas		
Limite de distância PIR	4,0 m, 5,5 m, 9,0 m (13 ft., 18 ft. 30 ft.)		
Velocidade detectável	0,3 m/s a 1,5 m/s (1 ft./s a 5 ft./s)		
Sensibilidade	2,0°C (3,6°F) a 0,6 m/s		
Entrada de alimentação	9,5 a 18 VDC		
Consumo de corrente	35 mA (máximo) a 12 VDC	40 mA (máximo) a 12 VDC	50 mA (máximo) a 12 VDC
Período de alarme	2,0 ±1 segundo		
Período de aquecimento	Approx. 60 segundos (o LED pisca)		
Saída de alarme	Forma C 28 VDC 0,2 A (máximo)		
Saída do tamper	N.F. 28VDC, 0,1 A (máximo) N.F. aberto quando a tampa for removida.		
Saída de problema	-	N.C. 28 VDC, 0,1 A (máximo)	
Entrada auxiliar	N.C. 28 VDC, 0,1 A (máximo)		
LED indicador	Vermelho: Aquecimento, Alarme	Vermelho: Aquecimento, Alarme, Problema	Vermelho: Aquecimento, Alarme, Problema Verde: Aquecimento, Detecção por PIR, Problema Amarelo: Aquecimento, detecção de microondas
Temperatura operacional	-20°C a +60°C (-4°F a +140°F)		
Umidade ambiental	95% no máximo		
À prova de intempéries	IP55		
Montagem	Parede		
Altura de montagem	2,5 a 3,0 m (8,2 a 10 ft.)		
Ângulo de ajuste do suporte	Vertical: ±20° ; Horizontal: ±95°		
Peso	600 g (21,2 oz.)		700 g (24,7 oz.)
Accessórios	Suporte, cobertura, vedação da área de mascaramento, 2 parafusos (3 x 10 mm), 4 parafusos (4 x 20 mm)		

* As especificações e os projetos estão sujeitos a mudança sem prévio aviso.

7-2 DIMENSÕES

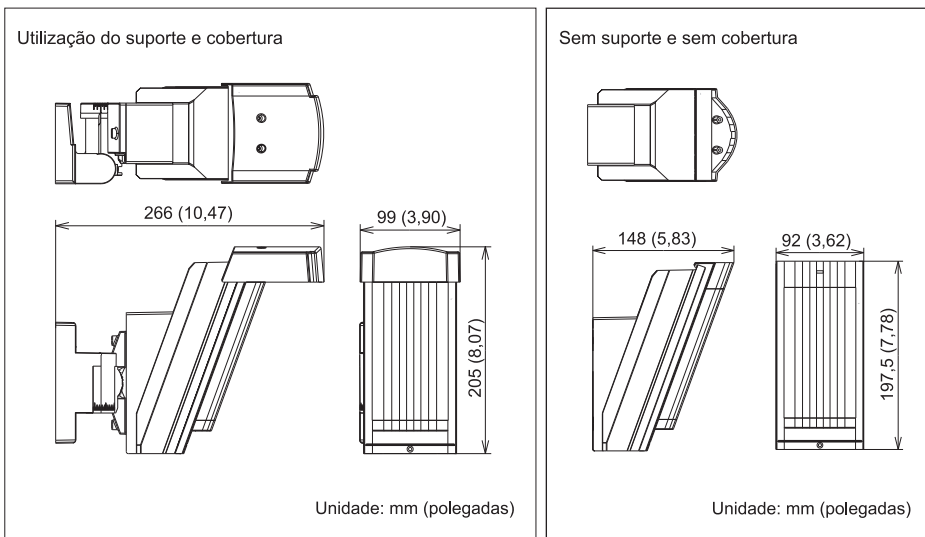

NOTE

The following statement will be provided with the equipment as required by Article 6.3 of the R&TTE Directive, 1999/5/EC.

The Optex HX series are in conformity with all essential requirements of the R&TTE Directive (1999/5/EC). This equipment has been assessed to the following standards:

EN 300 440-1: 2009

EN 50130-4: 2004 including amendment 2: 2003

EN 60950-1: 2006+A11: 2009

This product is marked with **CE0700** which signifies conformity with Class II product requirements specified in the R&TTE Directive.

The following list indicates the areas of intended use of the equipment and any known restrictions. For countries not included in this list, please consult the responsible Spectrum Management Agency.

9.900 GHz : Austria, Finland

10.525 GHz : Belgium, Denmark, Greece, Italy, Luxembourg, The Netherlands, Spain, Sweden, Iceland, Norway, Switzerland

10.587 GHz : Belgium, France, Ireland, Luxembourg, The Netherlands, United Kingdom

FCC ID : DC9 OPMW IC : 4012A-OPMW

This device complies with Part 15 of the FCC Rules. Operation is subject to the following two conditions:

(1) This device may not cause harmful interference, and (2) this device must accept any interference received, including interference that may cause undesired operation.

The HX-40 series is only a part of a complete system, therefore we cannot accept complete responsibility for any damages or other consequences resulting from an intrusion.



OPTEX CO., LTD. (JAPAN)

URL: <http://www.optex.net/>

OPTEX INC. (U.S.)

URL: <http://www.optexamerica.com/>

OPTEX DO BRASIL LTDA. (Brazil)

URL: <http://www.optex.net/br/es/sec/>

OPTEX (EUROPE) LTD. / EMEA HQ (U.K.)

URL: <http://www.optexeurope.com/>

**OPTEX TECHNOLOGIES B.V.
(The Netherlands)**

URL: <http://www.optex.eu/>

OPTEX SECURITY SAS (France)

URL: <http://www.optex-security.com/>

OPTEX SECURITY Sp.z o.o. (Poland)

URL: <http://www.optex.com.pl/>

OPTEX PINNACLE INDIA, PVT., LTD. (India)

URL: <http://www.optex.net/in/en/sec/>

OPTEX KOREA CO., LTD. (Korea)

URL: <http://www.optexkorea.com/>

**OPTEX (DONGGUAN) CO., LTD.
SHANGHAI OFFICE (China)**

URL: <http://www.optexchina.com/>