



**Safety Technology  
International**

## **UB-2 2" Universal Button**

UB-2/LTUL Universal Button with Latching Timer



**ADA**  
Compliant

For UB-2/LTUL the enclosed timer is to be used and installed per the enclosed LT-1UL installation sheet. For access control installations, power for the LT-1UL Timer must be supplied by a power source listed to UL294. When used for access control, this device shall be used as part of an access controlled egress door system. It is up to the local AHJ to allow use of this device in place of an automatic sensor. For higher security installations, lower time limits should be used.

Pour les modèles UB-2/LTUL, la minuterie intégrée doit être installée et utilisée suivant la fiche d'installation LT-1UL fournie. Pour les installations de contrôle d'accès, l'alimentation de la minuterie LT-1 doit être fournie par une source homologuée UL294. Lorsque cet appareil est utilisé aux fins de contrôle d'accès, il doit faire partie d'un système de porte de sortie à accès contrôlé. Il incombe donc à l'AHJ local d'autoriser l'utilisation de cet appareil au lieu d'un capteur automatique. Pour les installations de sécurité plus renforcée, des délais inférieurs doivent être utilisés.

**We protect the things that protect you.®**

## NOTES

It is important to read, understand and follow all instructions provided with this product. It is the installer's responsibility to comply with NFPA 70 & 101, NEC, mounting specifications according to ADA and other applicable electrical codes. This switch is rated Type NM (Non-Monitored) for non-emergency signaling. Not to be used in place of panic hardware. To avoid electrical shock, DO NOT attempt to install this product when power is on. ADA mounting compliance requires the operable part of the initiating device shall not be less than 3 1/2 ft. (1.1m ) or greater than 4 1/2 ft. (1.37m) above finished floor surface. After installation and testing are complete, provide a copy of this manual to all personnel responsible for testing and maintenance of this product.

## REMARQUES

Il est important de lire, de comprendre et de suivre toutes les instructions fournies avec ce produit. Il incombe à l'installateur de se conformer aux normes NFPA 70 et 101, NEC, aux spécifications de montage selon l'ADA et aux autres codes de l'électricité en vigueur. Pour les cotes de type SM (auto surveillée), le message d'Urgence peut être apposé sur le modèle UB-1 lorsqu'il est utilisé dans un système intégrant un dispositif de déclenchement compatible et homologué. Toutes les autres applications sont cotées de Type NM (non surveillée) pour la signalisation non urgente. Pour éviter un choc électrique, NE tentez PAS d'installer ce produit lorsqu'il est sous tension. La conformité aux règles d'installation de l'ADA exige que la partie utilisable du dispositif de déclenchement soit installée à une hauteur située entre 3 1/2 pi (1,1 m) et 4 1/2 pi (1,37 m) au-dessus du plancher fini. Une fois l'installation et les essais terminés, vous devez fournir une copie de ce manuel à l'ensemble du personnel chargé de l'essai et de l'entretien de ce produit.

## SWITCH RATING

2 Independent Form "C" contacts

UB-2 rated at: 10A, 1/2 HP, 125/250 VAC

6A, 30 VDC

100,000 Operations

Temperature: -40° to 185°F (-40° to 85°C)

Model UB -2/LTUL

Form "C" contacts on timer rated:

30 VDC 3A, 1.0 pf

## UL294 Performance Levels:

Line Security: I

Attack: I

Endurance: IV

Standby Power: I

## 1. TO CHANGE BUTTON COLOR AND ROUND MESSAGE

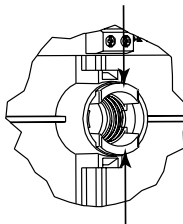
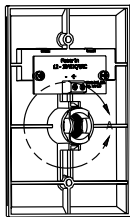
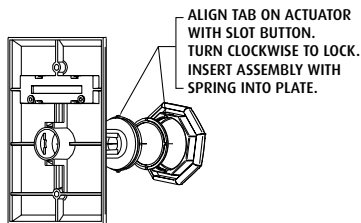
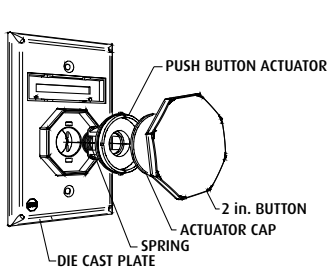

1. Choose button message and color. If same as existing, proceed to **2**.
2. To remove push button actuator assembly, pinch together actuator tabs in direction of arrows shown above and push through plate.
3. Push actuator through plate.
4. Align actuator cap to push button actuator. Align button slots to tabs on push button actuator.
5. Snap button onto push button actuator and rotate right to lock.
6. Insert spring into push button actuator.
7. Pinch legs of push button actuator and align into die cast plate.

## 2. CHANGE TOP MESSAGE

Refer to notes on page 2 for “EMERGENCY” message use.

1. Remove LED circuit board.
2. Remove current message by pushing in and down on tabs 1 and 2 with a small screwdriver. If necessary, also push in and down on tabs 3 and 4. Once message is loose, remove from the front of the plate.
3. Select new message and snap into place. Blank plates are included to create your own custom message.

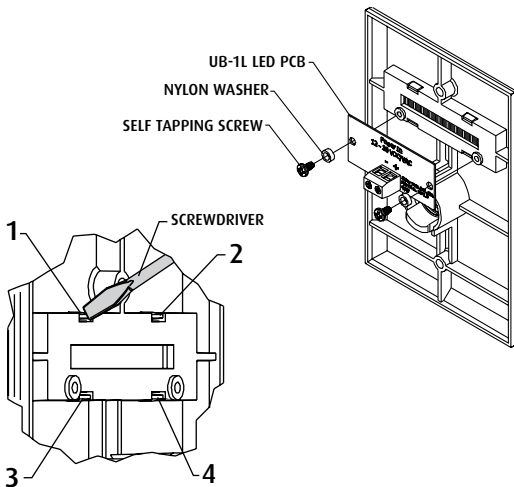

### 3. INSTALL OR REMOVE CONTACT BLOCK

#### INSTALL

To attach, align tabs (as shown) and gently snap **top, then bottom**. Be sure to hear **BOTH** tabs snap into place. (Can be reversed if wiring comes from the top of the box.)

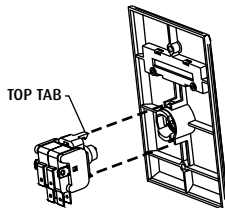

#### REMOVE

Repeat **STEP A** for the top and bottom tab before removing contact block.

**Step A:** Position small flat screwdriver blade under tab and gently rotate until tab disengages. The contact block will rotate a little. Do NOT pull yet.

**Step B:** Repeat for opposite tab.

**Step C:** When both tabs are disengaged, pull the contact block straight off.

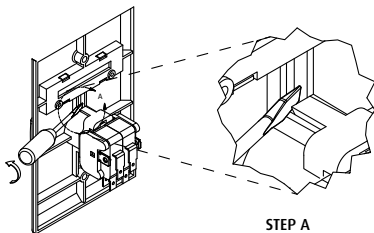

STEP A

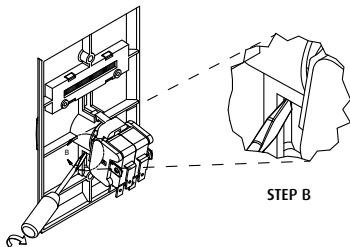
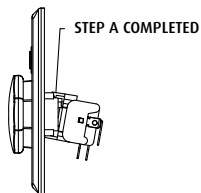

STEP B

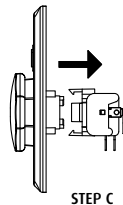

STEP C

#### 4. ATTACH POWER FOR MESSAGE LED IF DESIRED

(See drawing)

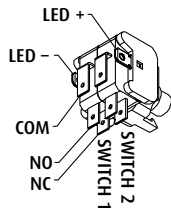
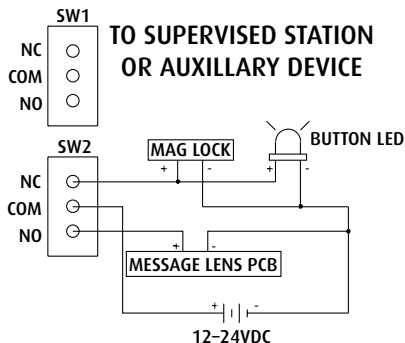

	<u>NORMAL POSITION</u>	<u>BUTTON ACTIVATED</u>
MAGNETIC LOCK	ON	OFF
BUTTON LAMP	ON	OFF
MESSAGE LAMP	OFF	ON

#### NOTE

**LED connection:** The polarity shown is factory installed. LED is polarity sensitive. If LED does not light, switch positive and negative wiring or remove LED and rotate 180°. 24 volt is included and will operate on 12 volts; however not as bright. 12 volt LED's are also available.

## 5. MOUNT BUTTON ONTO ELECTRICAL BOX

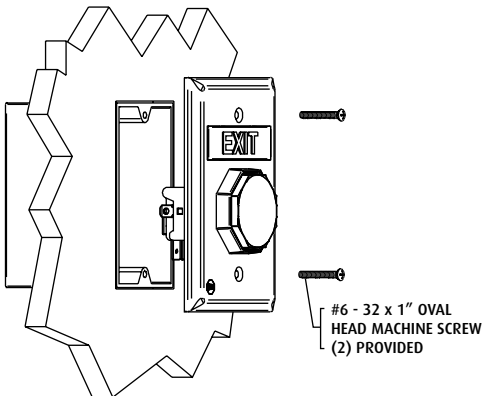

## 6. CUSTOM LABELS

To create your own custom label, size to fit in .48h x 2.23w as shown below.  
Also available online at: [www.sti-usa.com/ublabel](http://www.sti-usa.com/ublabel)

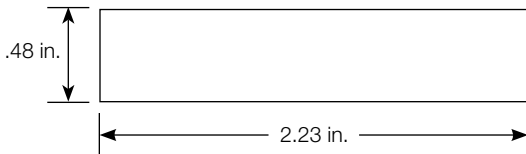

## Warranty

Three year guarantee against breakage of polycarbonate in normal use (one year on electro mechanical and electronic components). Electronic warranty form at [www.sti-usa.com/wc14](http://www.sti-usa.com/wc14).

**⚠ WARNING:** This product can expose you to chemicals including Dichloromethane, which is known to the State of California to cause cancer, and Bisphenol A (BPA), which is known to the State of California to cause birth defects or other reproductive harm. For more information go to [www.P65Warnings.ca.gov](http://www.P65Warnings.ca.gov).

## ACCESSORIES

### PART # DESCRIPTION

KIT-71100A-\* COLOR MATCH BACK BOX KIT

\* (R=Red, B=Blue, G=Green, W=White Or Y=Yellow)

UB-1CL-\* CUSTOM LABEL APPLIED TO BLANK MESSAGE PLATES

\* (B=Blue, G=Green, W=White Or Y=Yellow)

UB-1LENS BUTTON REPLACEMENT LENSES: (red, green & blue)

UB-2LENS 2" LENS KIT FOR UNIVERSAL BUTTON

KIT-UB-1C CONTACT ASSEMBLY FOR UB-1

24 VOLT LED  
KIT-E10147 WHITE (STANDARD)  
KIT-E10145 RED  
KIT-E10141 BLUE  
KIT-E10143 GREEN

12 VOLT LED  
KIT-E10144 RED  
KIT-E10140 BLUE  
KIT-E10142 GREEN

COVERS  
STI-6518 BOPPER STOPPER  
STI-13000 Series UNIVERSAL STOPPER  
STI-1100 Series STOPPER II®

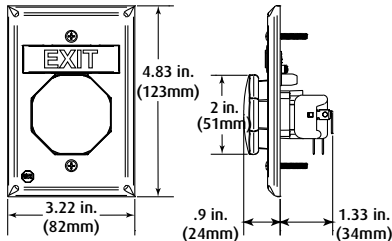

**- See website for complete cover details -**



**Safety Technology  
International**

2306 Airport Rd • Waterford, MI 48327, USA  
Phone: 248-673-9898 • Fax: 248-673-1246  
info@sti-usa.com • www.sti-usa.com

Taylor House • 34 Sherwood Road • Bromsgrove, Worcestershire • B60 3DR • England  
Tel: +44 (0)1527 520 999 • Fax: +44 (0)1527 501 999 • info@sti-emea.com • www.sti-emea.com